	<p>Floor raiser 1</p>	<p>2</p>
	<p>Floor raiser 2</p>	<p>2</p>
	<p>Support rail 1</p>	<p>4</p>
	<p>Support rail 2</p>	<p>4</p>
	<p>Back wall 1</p>	<p>1</p>

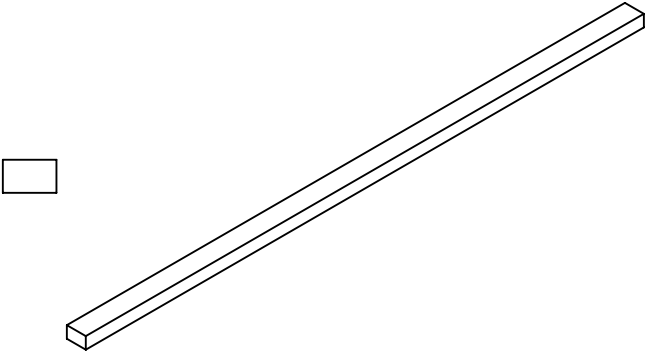

Back wall 2

1

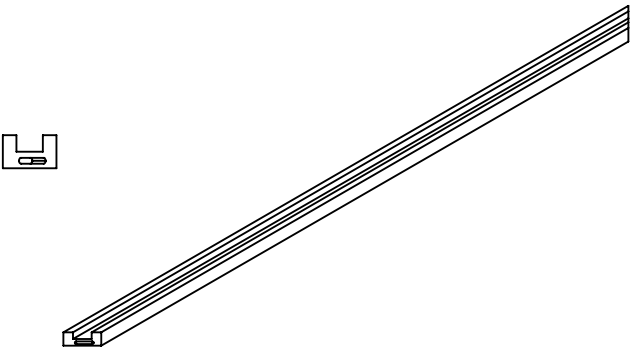
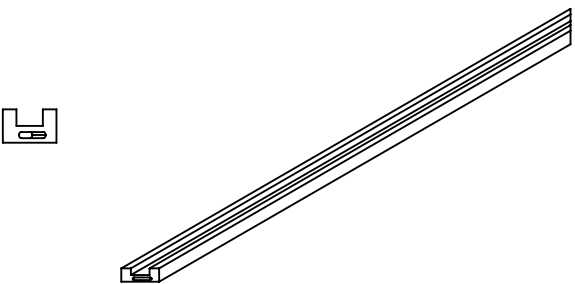
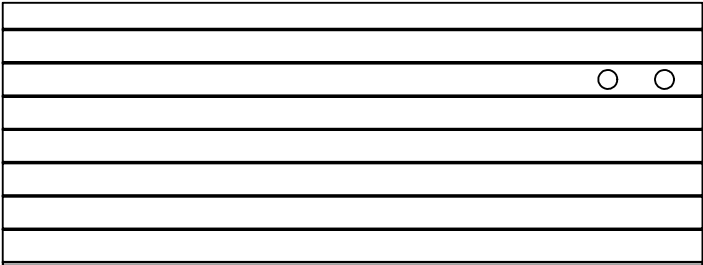
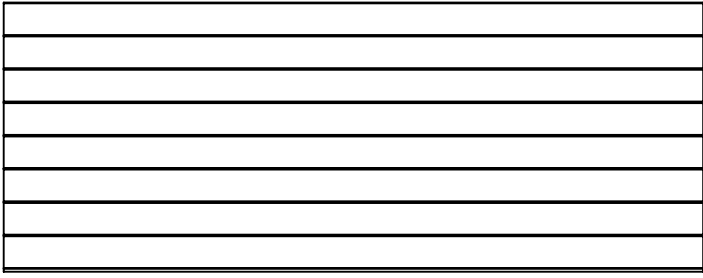

Back wall 3

1



Side wall 1

2

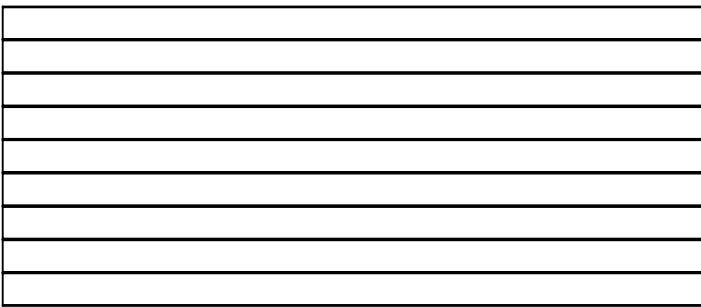

Side wall 2

1



Side wall 3

1

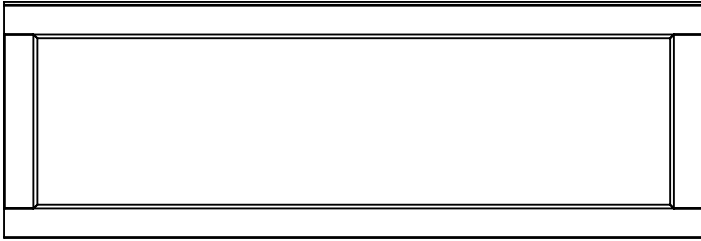

Window Element

2

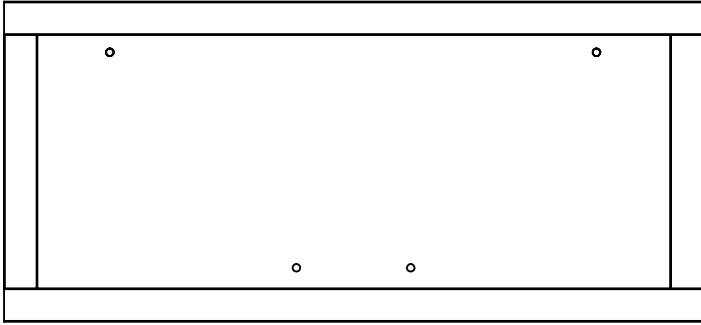

Door Element

1

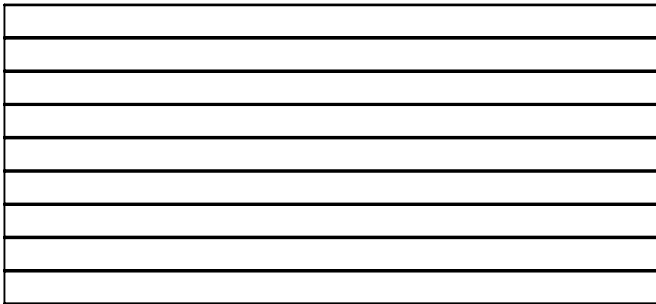

Roof 1

1



Roof 2

2

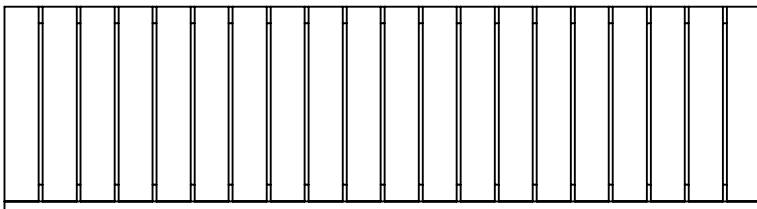

Upper Bench

1

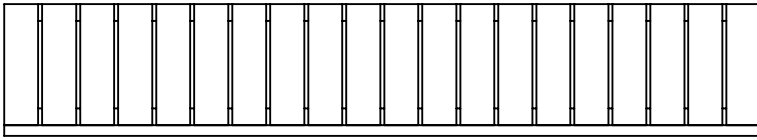

Lower Bench

1

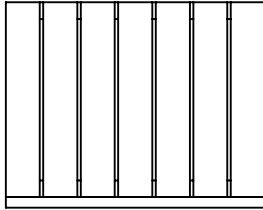

Side Bench

1



Backrest 1

1

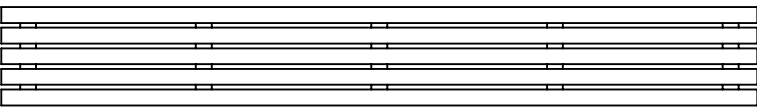

Backrest 2

1

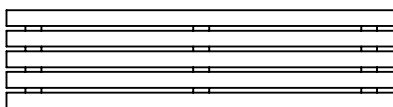

Backrest 3

1

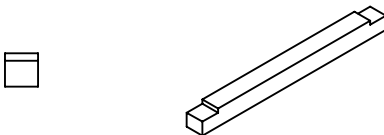

Bench Support 1

2



Bench Support 2

2

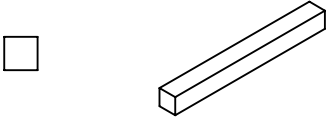
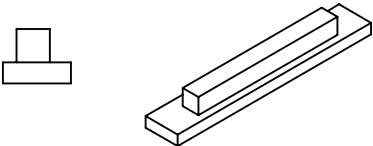
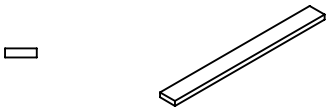
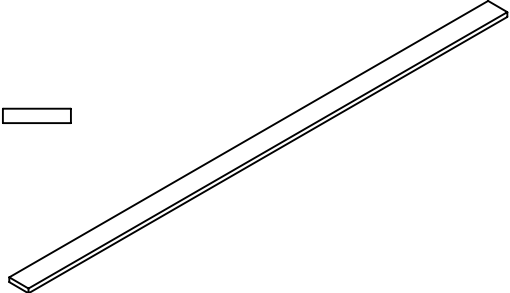
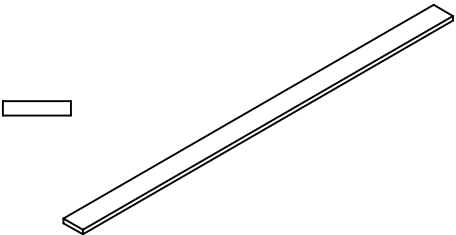
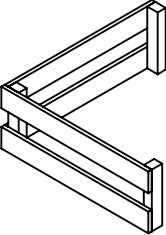
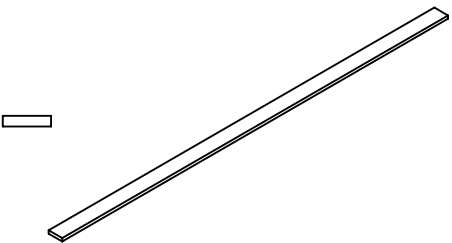
	<p>Side Bench Support 1</p>	<p>1</p>
	<p>Side Bench Support 2</p>	<p>1</p>
	<p>Backrest 2 Vertical Slat</p>	<p>3</p>
	<p>Cornice Board 1</p>	<p>1</p>
	<p>Cornice Board 2</p>	<p>2</p>
	<p>Heater Cover</p>	<p>1</p>
	<p>Front Wall Cover Slat</p>	<p>2</p>

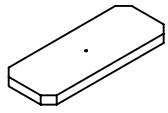

Vent Cover

1

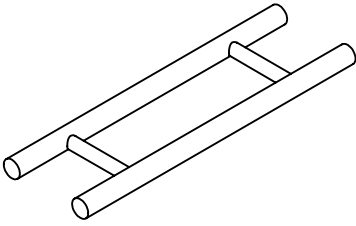

Door Handle

1

Screws	Qty
5x80	8
4,5x70	47
4x60	8
4x50	50
3,5x40	28
3,5x35	6
3,5x25	9
3x20	16
Washer for vent cover	1
Tenon	8

Step 1. Connect the Four Floor Raisers

Fasten the four floor raisers together using 5x80 screws, being sure the two shorter boards are located on the sides and the two longer boards are on the front and back. Use a framing square to ensure the assembly is square.

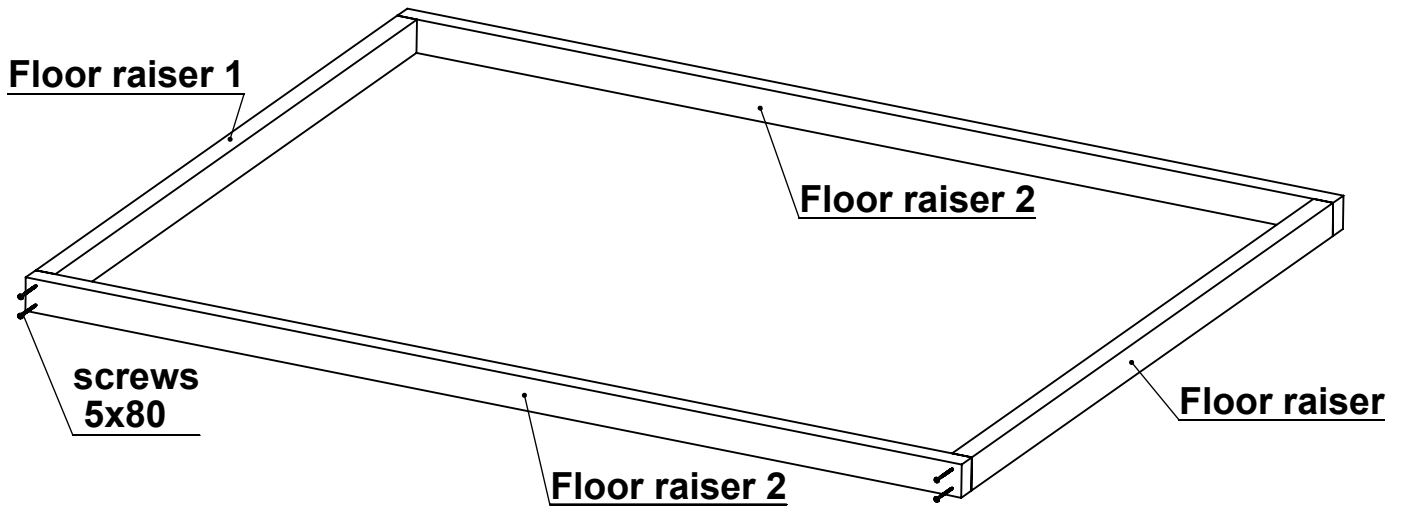
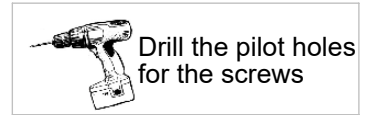

Step 2. Connect Wall Support Rails

Each wall support has a predrilled hole for tenon. Insert the tenons in the longer support rail holes. Fasten the wall support rails together and connect from corners using 4pcs 3x20 screws per corner.

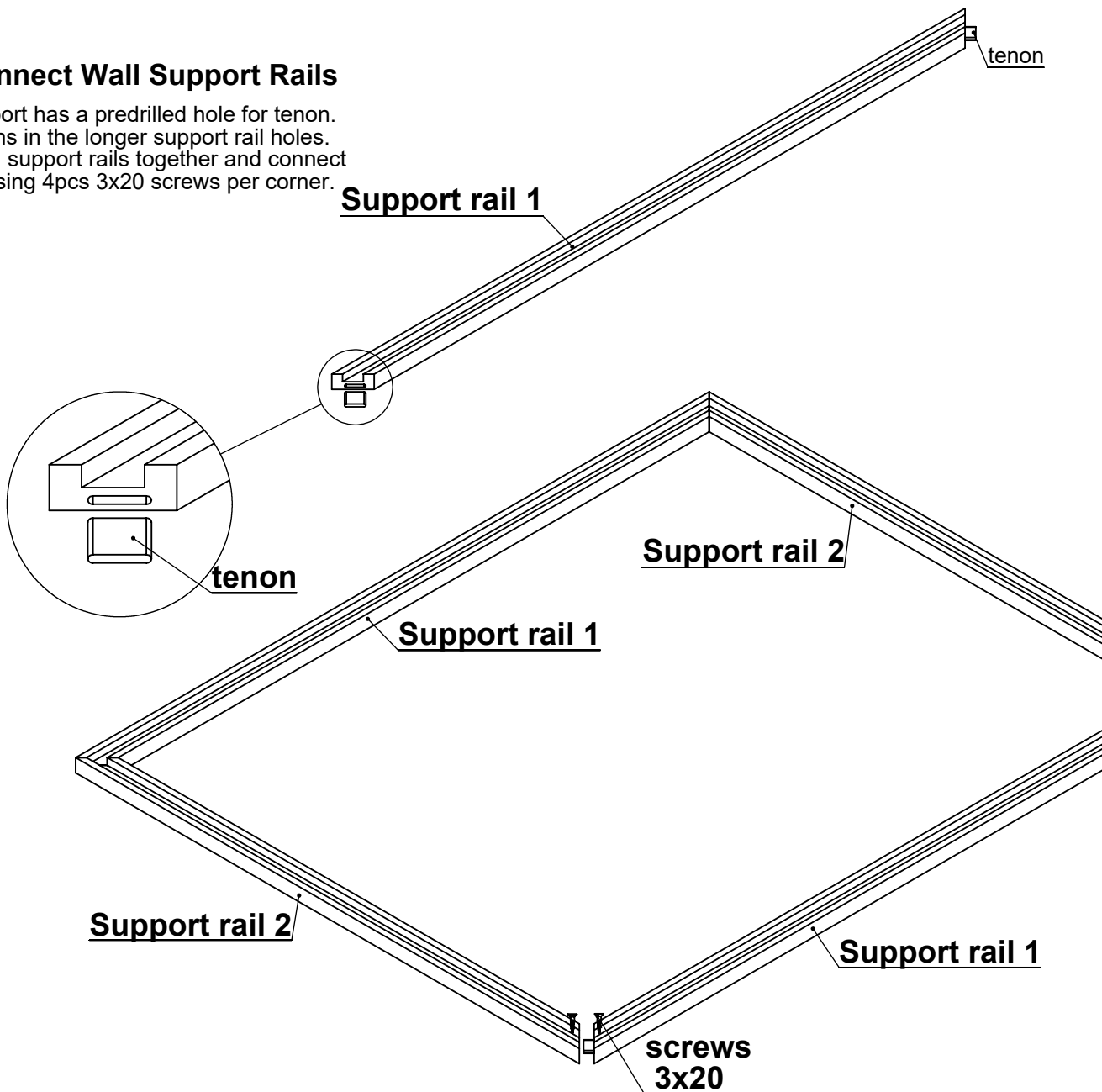

Step 3. Position Wall Support Rails

Lay the wall support rail assembly squarely on top of the floor risers with the groove facing up. The rails should overlap both sides of the riser by approximately 0,5". Secure the assembly to the floor risers using four screws evenly spaced on each wall support rail

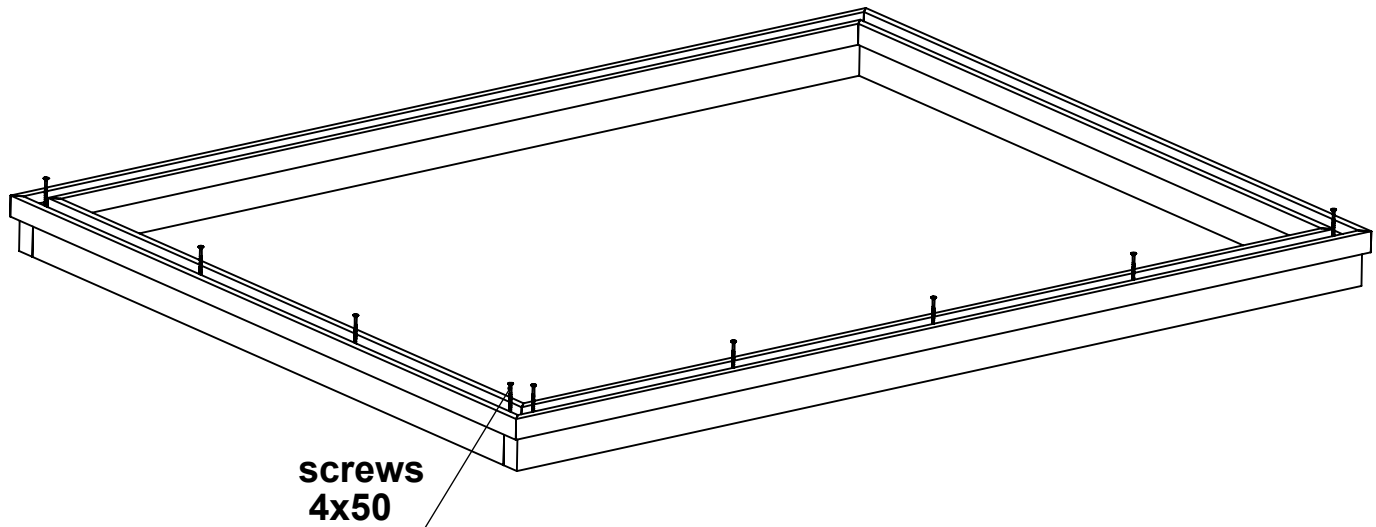

Step 4. Position Wall Sections (back wall1&side wall1)

Position backwall section 1 in the groove of the back rail and push it flush against the left rail. Having a helper hold back wall section , orient side wall section 1 and place it in the groove of the left rail. Push the flat edge flush against back wall section. Align the two panels so they are flush and fasten them together using the 4,5x70 screws

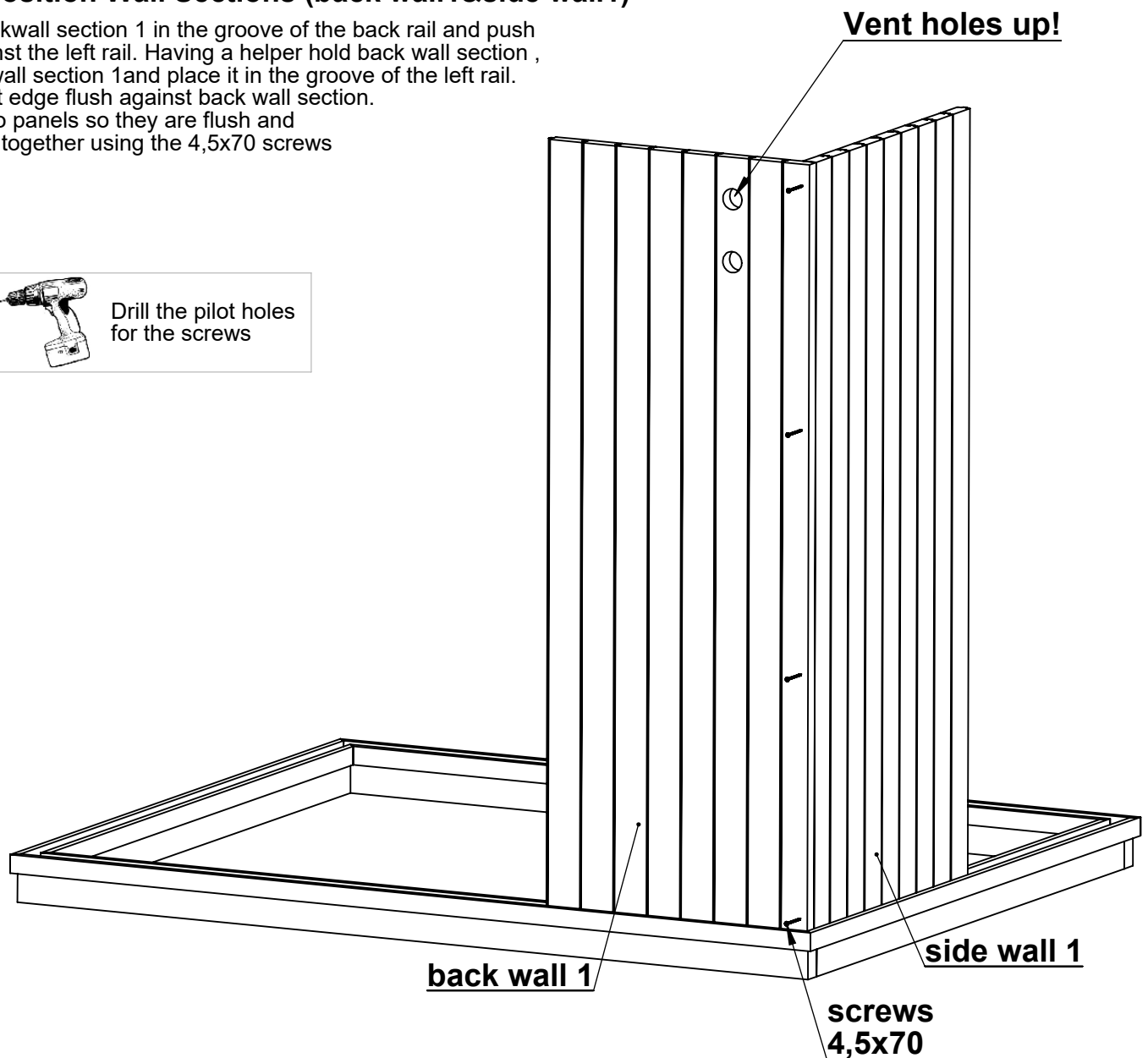
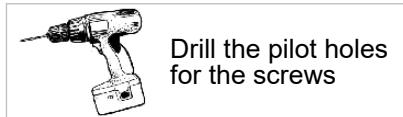

Step 5. Position back wall sections 2&3, and side wall1

Position back wall2 section into the groove of the back rail. Attach it to back wall section 1 by way of the tongue and groove fit. Secure it by tapping it into place with a rubber mallet. Repeat this step for wall section3, again tapping it into place with a rubber mallet. Position side wall section 1 into the groove to the right side rail and push flush against the back wall. Being sure panels are flush with each other, fasten them together using the 4,5x70 screws.

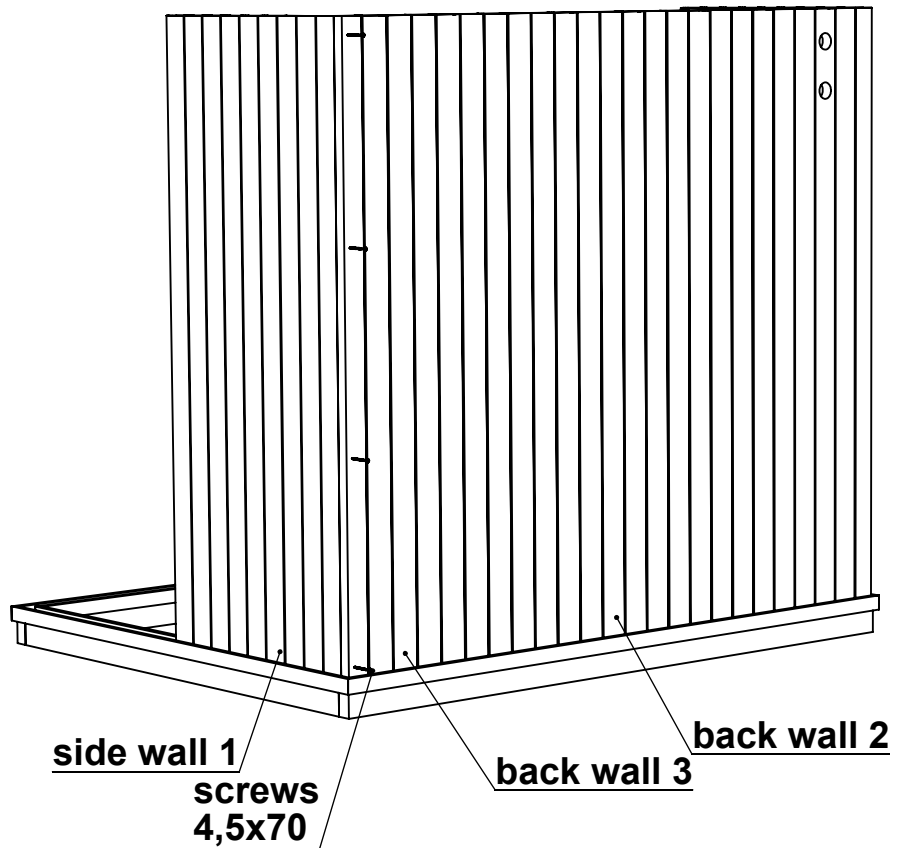
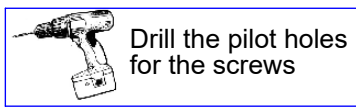

Step 6. Position side wall section2, window section and door section

Position side wall section2 into the groove of the side rail. Slide side wall section2 into place with side wall section1. Section 2 connects to section 1 via tongue and groove so there is no need to use screws. Use a rubber mallet to secure the fit. Place window section in the groove on the front rail and push against side rail. Being sure the two sections are flush, fasten them together using 4,5x70 screws. Place door section onto the front rail orienting it so that the door opens according to your preference. Door section connects to window section via tongue and groove so there is no need for screws. Gently tap it into place with a rubber mallet to secure the fit.

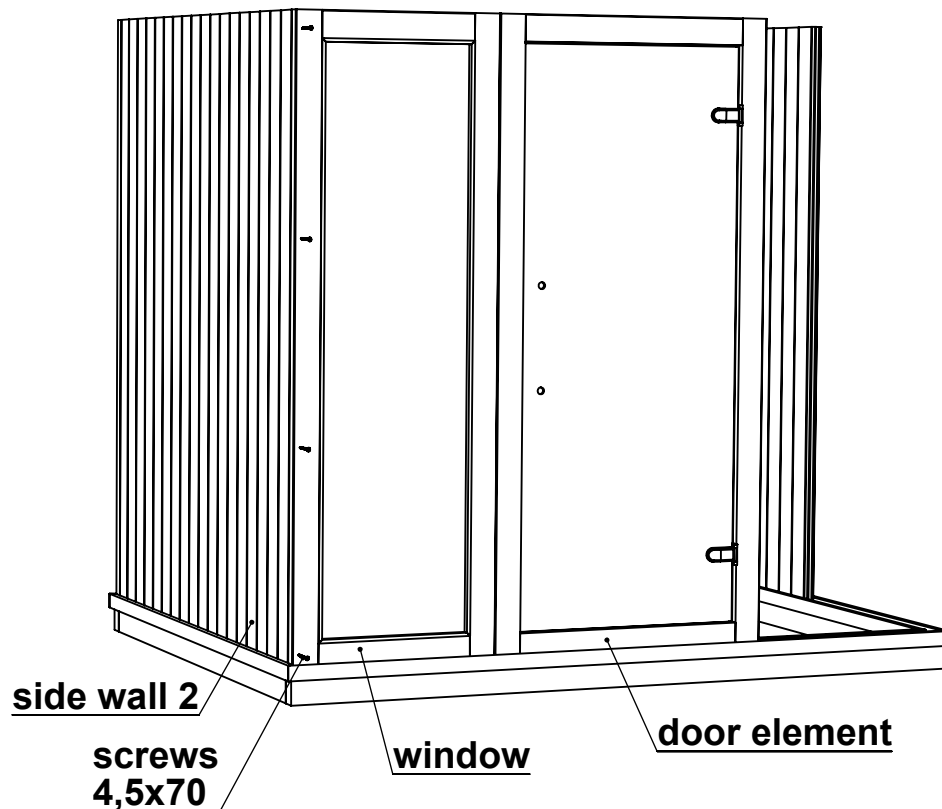

Step 7. Position Window section and Side Wall section 3

Position side wall section 3 into the groove of the side rail orienting it so that the heater vent holes are located at the bottom. Slide wall section into place with sidewall section 1. Side wall 3 connects to side wall 1 via tongue and groove so there is no need to use screws.

Use a rubber mallet to secure the fit.

Now place window section into the groove of the front rail and connect it to door section via the tongue and groove fit. Gently tap into place with a rubber mallet to secure the fit. Now, making sure window section and side wall 3 are flush with each other, secure them together with the 4,5x70 screws.



drill the pilot holes for the screws

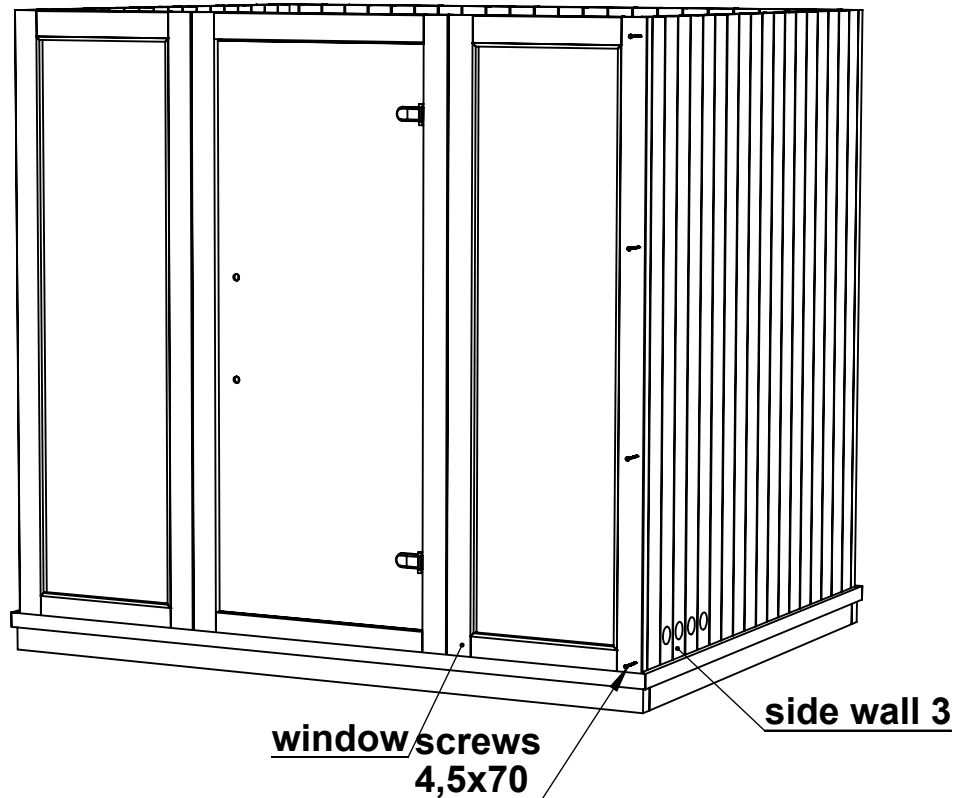

Step 8. Assemble and Position Roof Support Rails

Watch the step 2 and connect roof support rails in the same way.

Place the assembly on top of the wall sections so that the wall sections fit snugly into the groove. When in place, secure to the assembly to the walls using four 4x50 screws on each rail.

roof support rail

screws
4x50

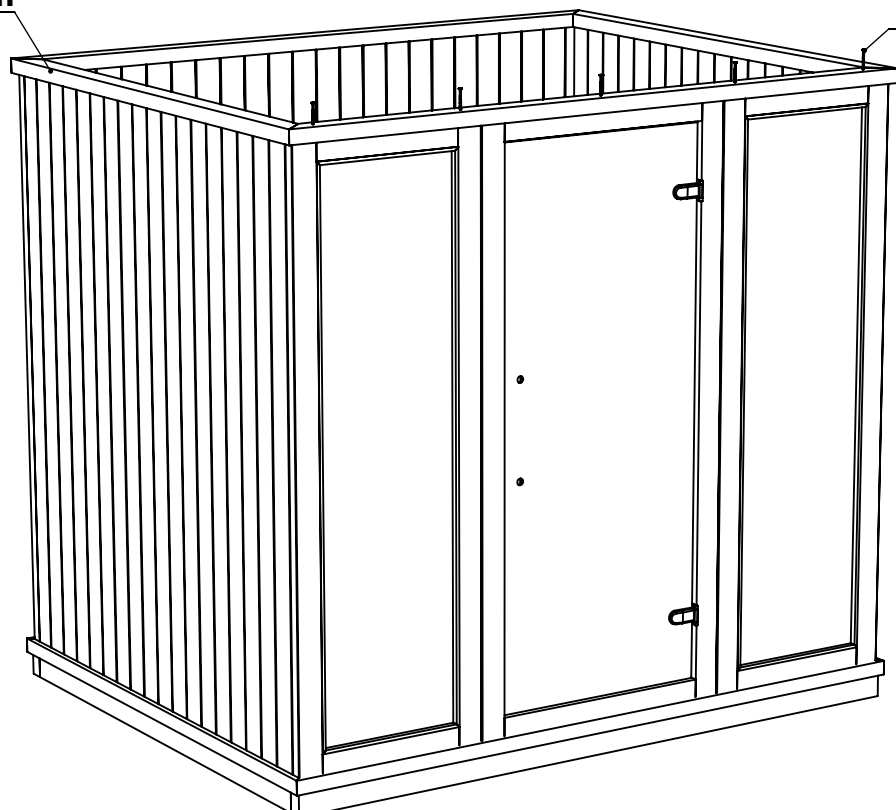

Step 9. Bench, lower bench installation

Use 4,5x70 screws to connect the bench supports to the wall. Make sure the supports in both walls are in same height. When the supports are assembled place the benches on the supports. Use three 4,5x70 screws to connect the seat bench to the back wall.

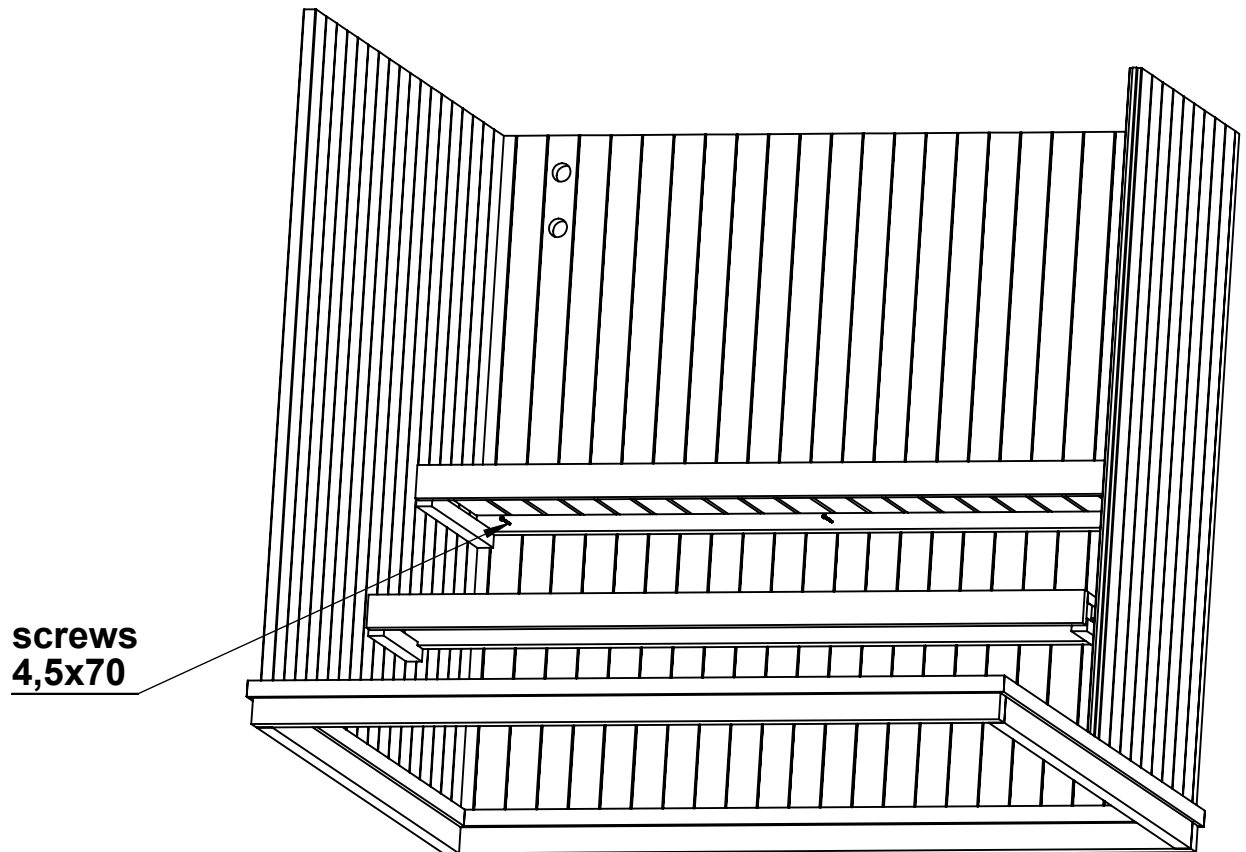
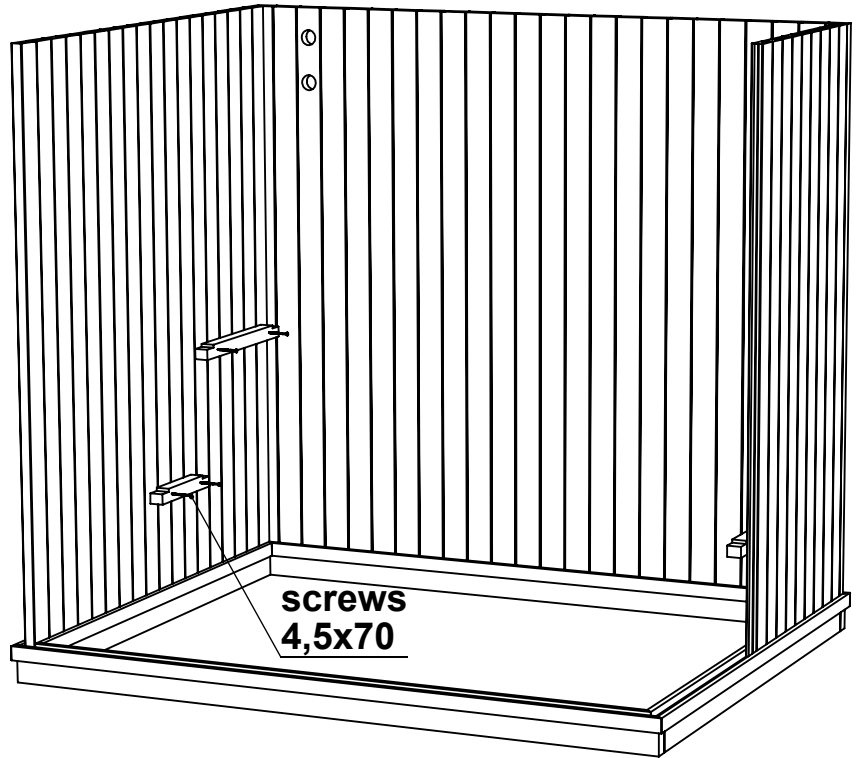
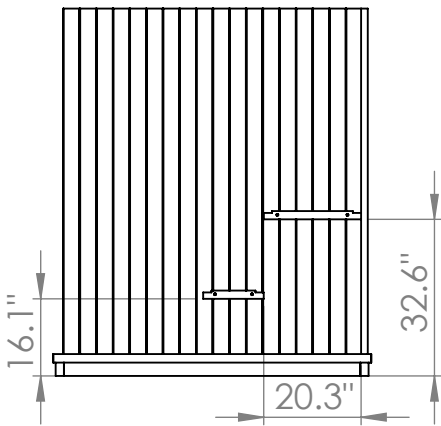

Step 10. Backrest installation

Center the backrest between the two sides and position it vertically at a height most comfortable for you (typically 8-12" from the bench). Using a level to ensure proper installation, fasten the backrest into place using the 4,5x70 screws.

Use 3,5x25 screws to connect the vertical slats to the backrest, check the dimensions on drawings. Now attach the backrest between the upper and lower bench using 3,5x35 screws.

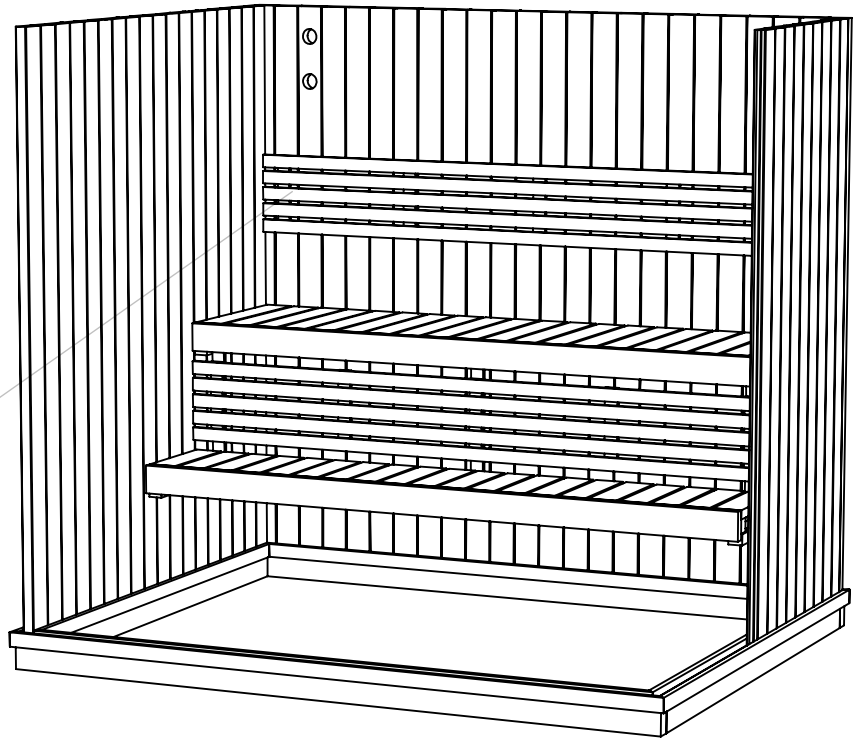

screws
4,5x70

Step1

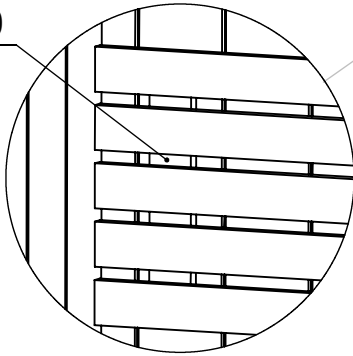

Step2

backrest

screws
3,5x25

2.1"

4.2"

backrest vertical slat

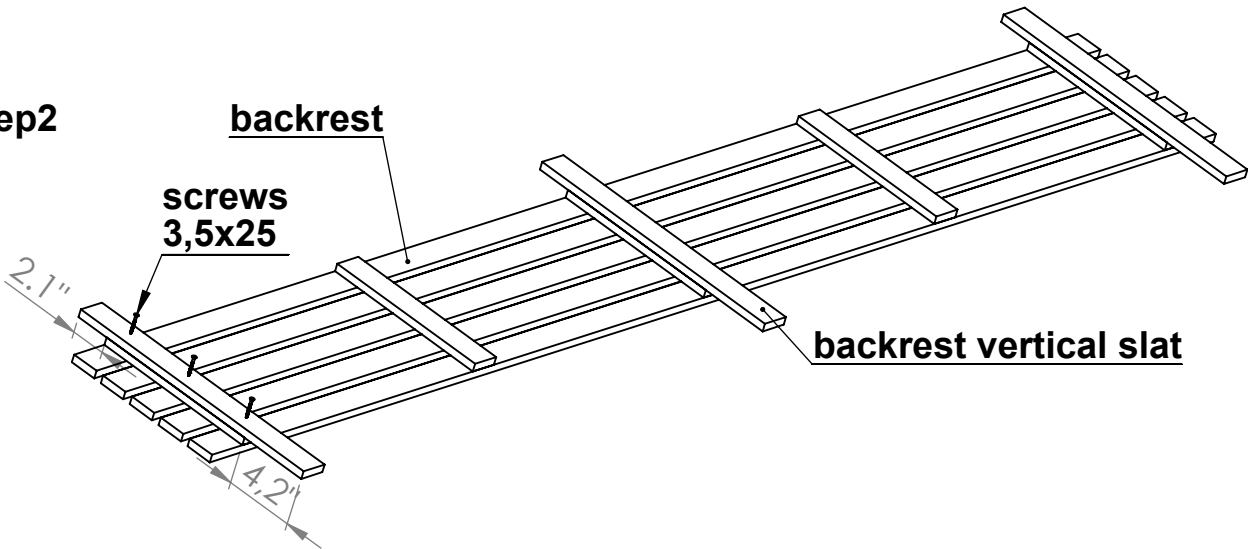

Step3

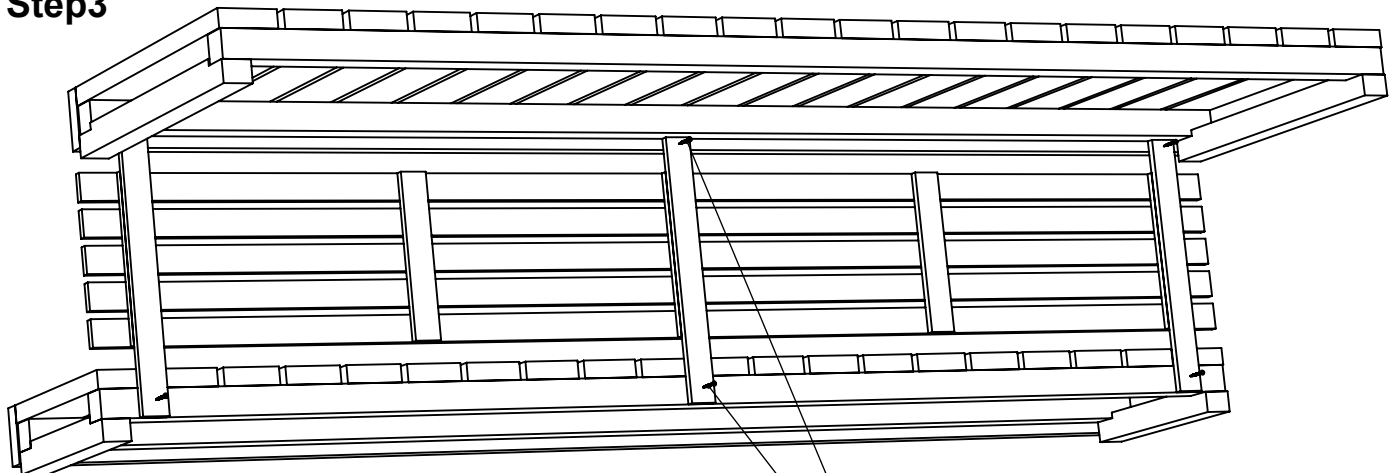

screws
3,5x35

Step 11. Side bench installation

Attach the side bench support 1 to the lower bench, using two 4,5x70 screws. Gap between the support and the side wall must be 2". Side bench support 2 connect to the window section using 4x60 screws. Support must be in the same height with lower bench. Place the side bench on the supports and fasten with two 4,5x70 screws to the side wall element.

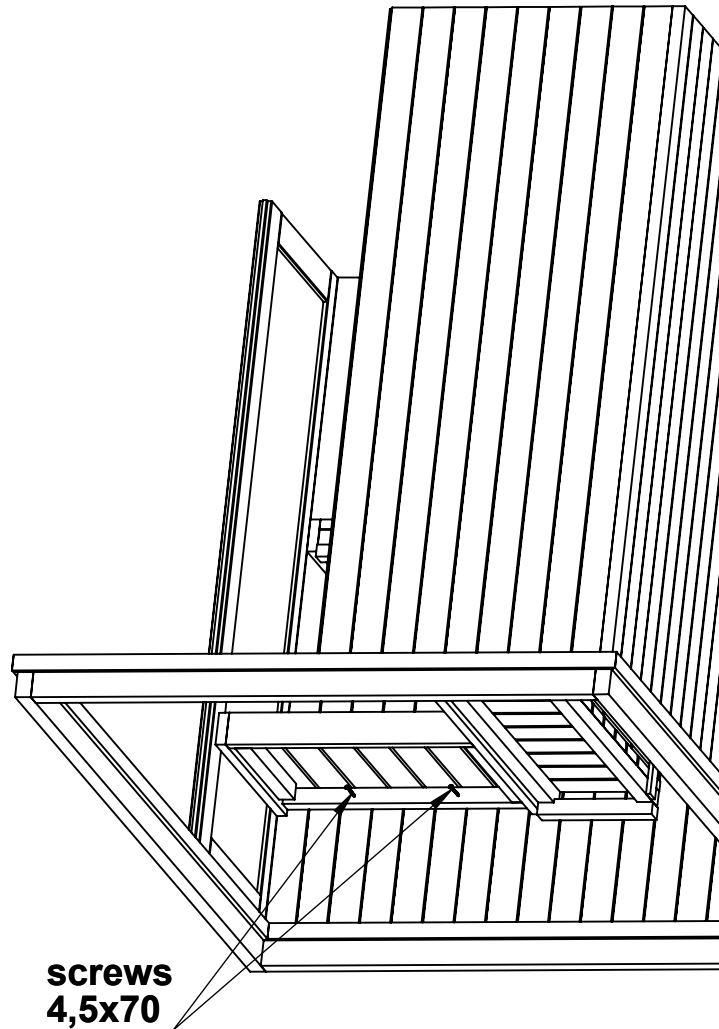
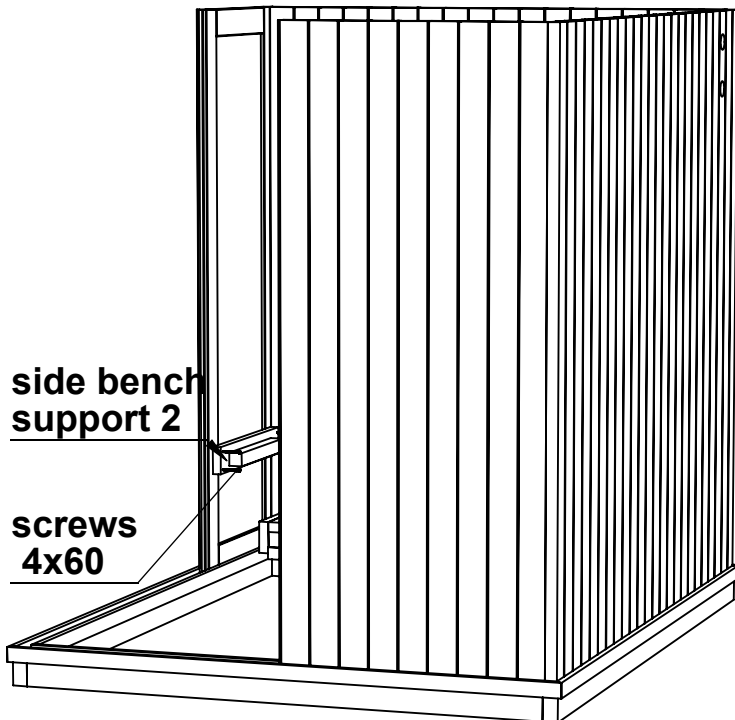
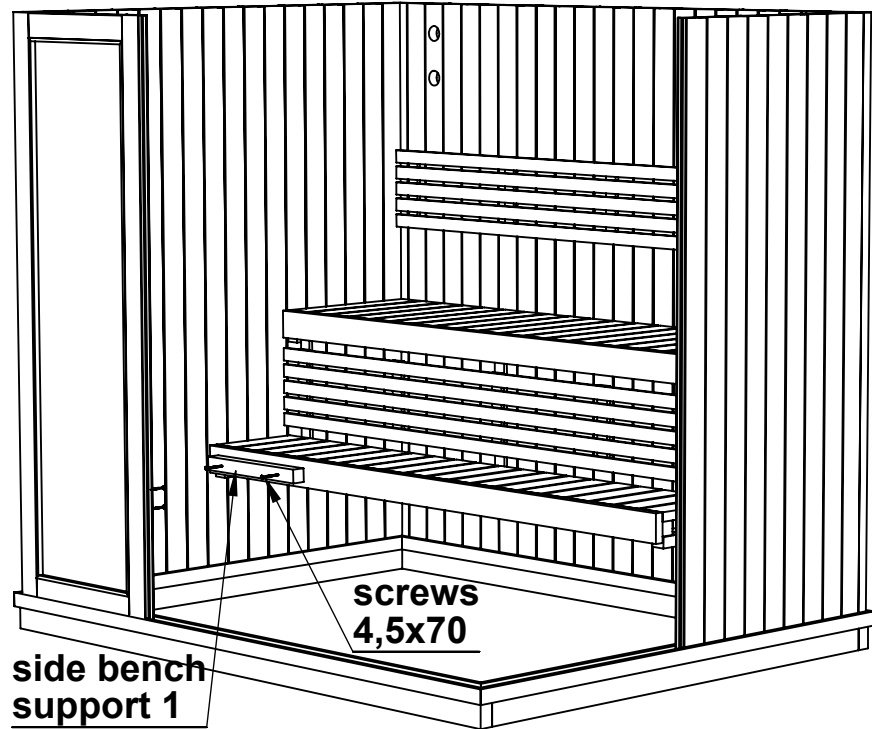
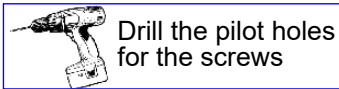

Step 12. Lower backrest installation

Using a level, secure the lower backrest to side wall section with 4,5x70 screws at the same height above the upper long bench.

screws
4,5x70

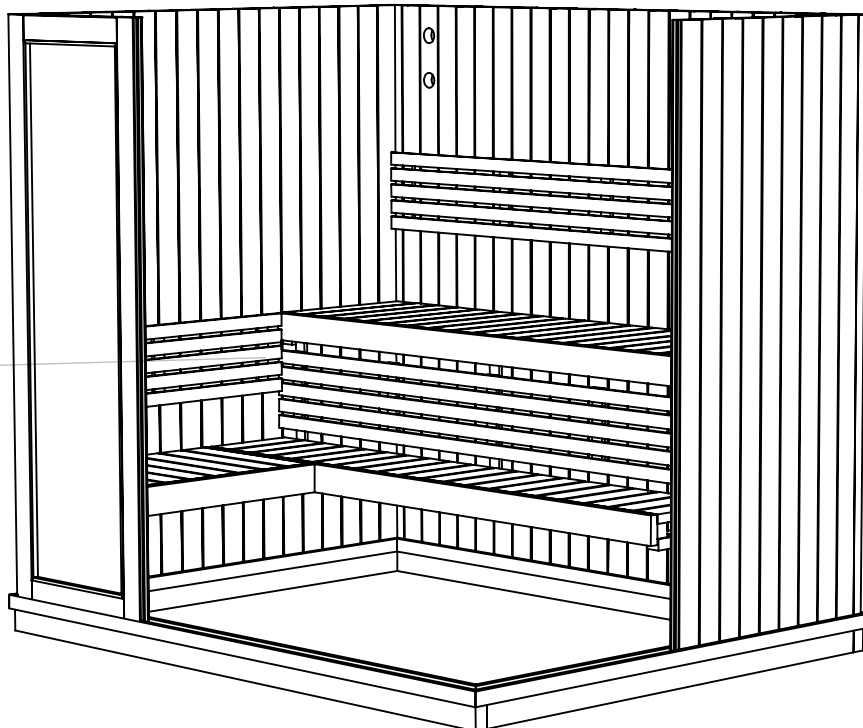
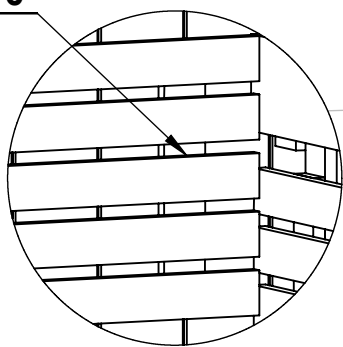

Step 13. Position Roof Sections

Place the roof panels on top of the ceiling supports. Connect the sections via the tongue and groove fit. From the backside roof panels must be in the same line with ceiling supports. Position the both sides equal. Connect panels with 4x50 screws.



Drill the pilot holes
for the screws

roof section1

roof section2

screws
4x50

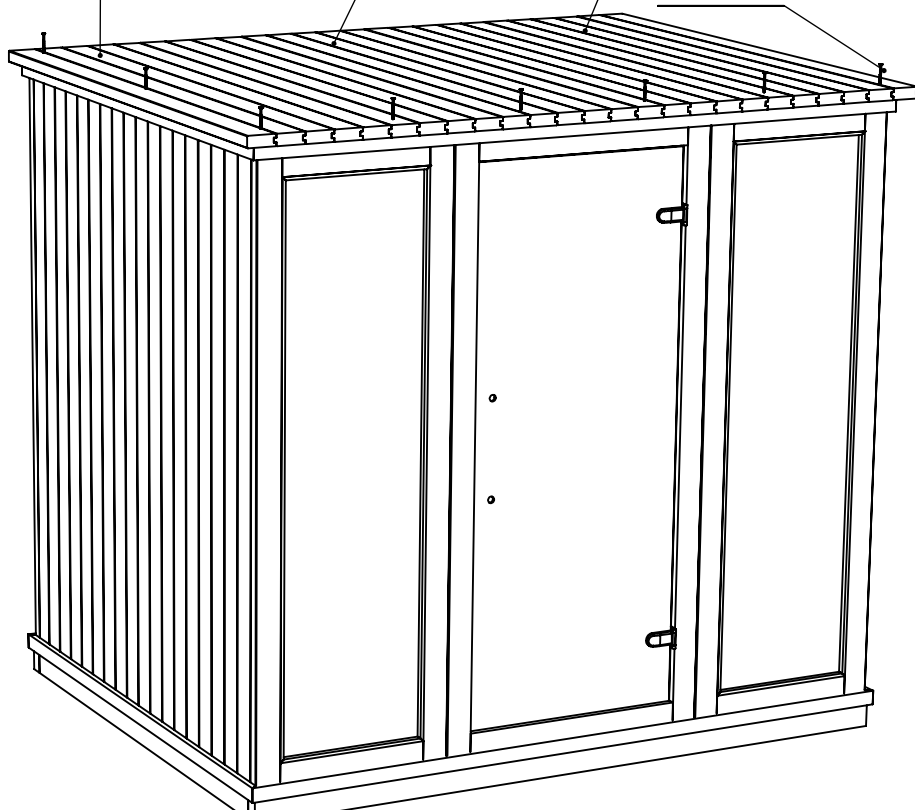

Step 14. Cornice boards

Connect the cornice boards to the roof, using 3,5x40 screws.

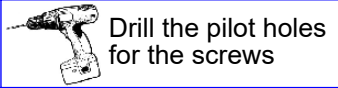
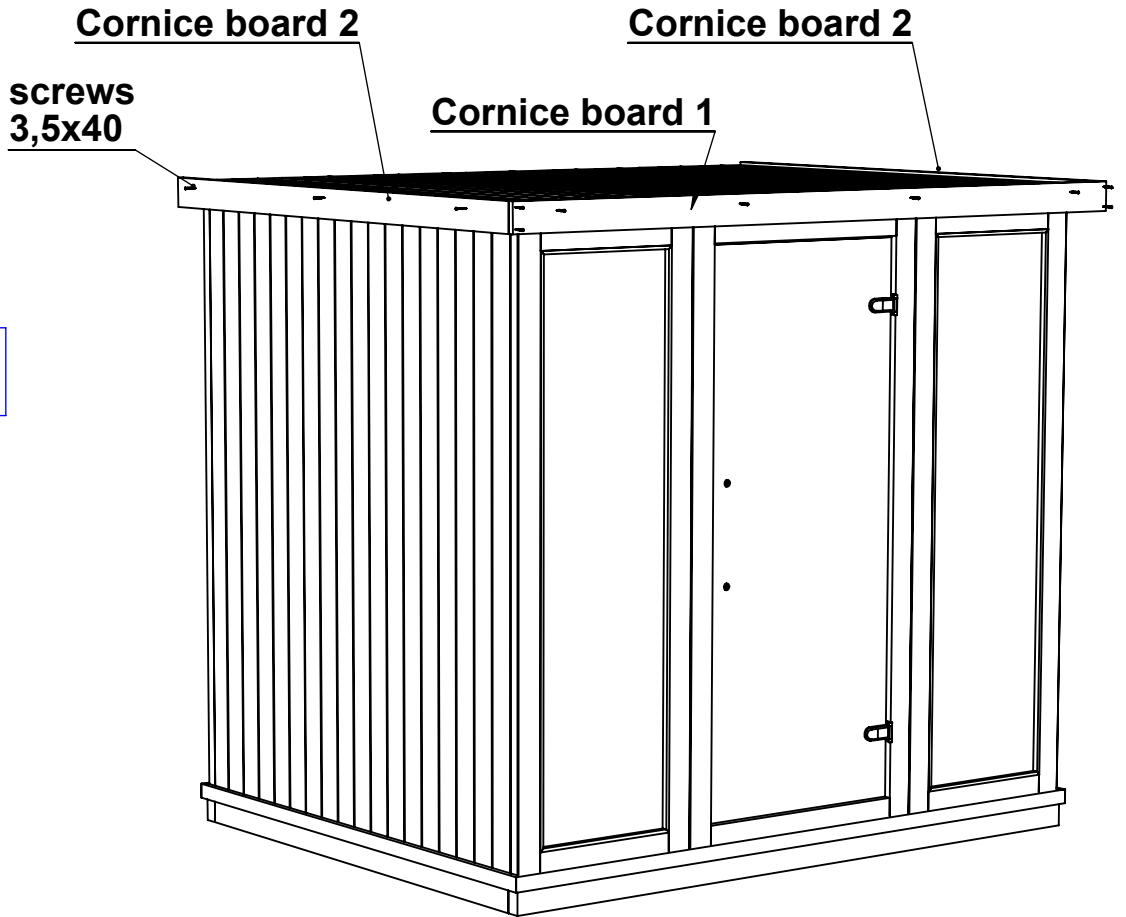

Step 15. Vent cover and door handle.

Connect vent cover with 3,5x40 screw. Between wall and vent cover add small washer.

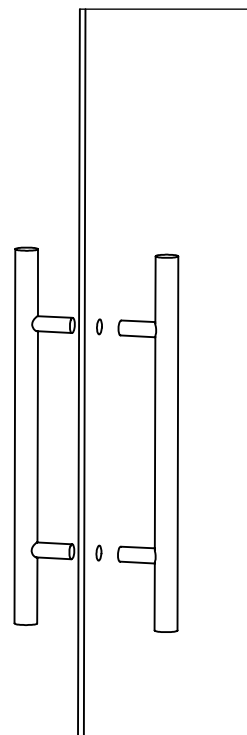
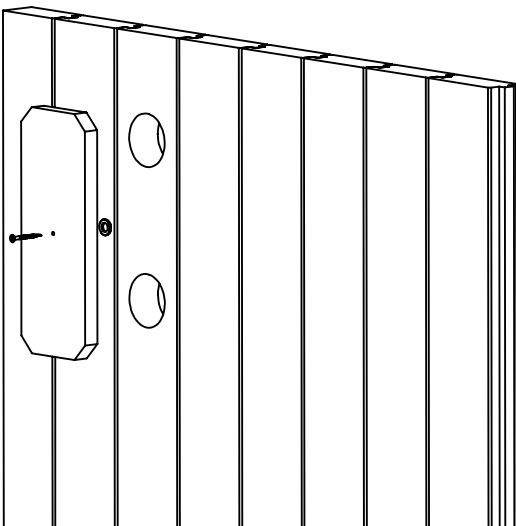

Step 16. Heater cover

Connect the heater cover to the wall with 4x60 screws.
Make this step when heater is already installed.

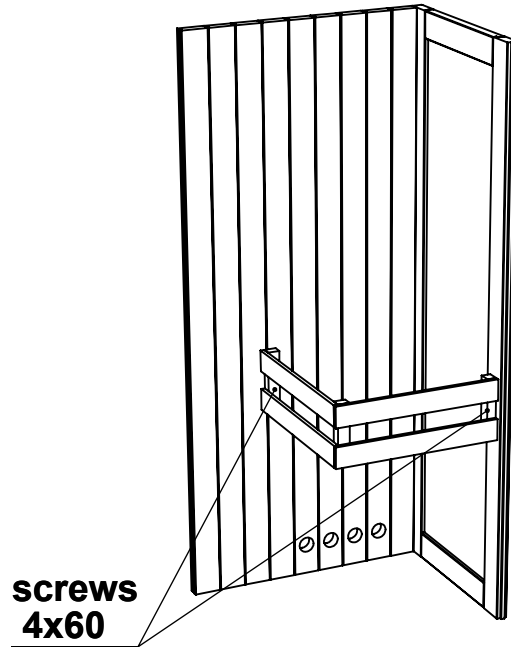
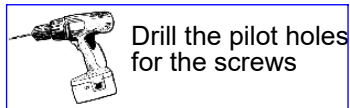

Step 17. Cover slats to the front wall

Connect the cover slats using
3,5x40 screws.

