

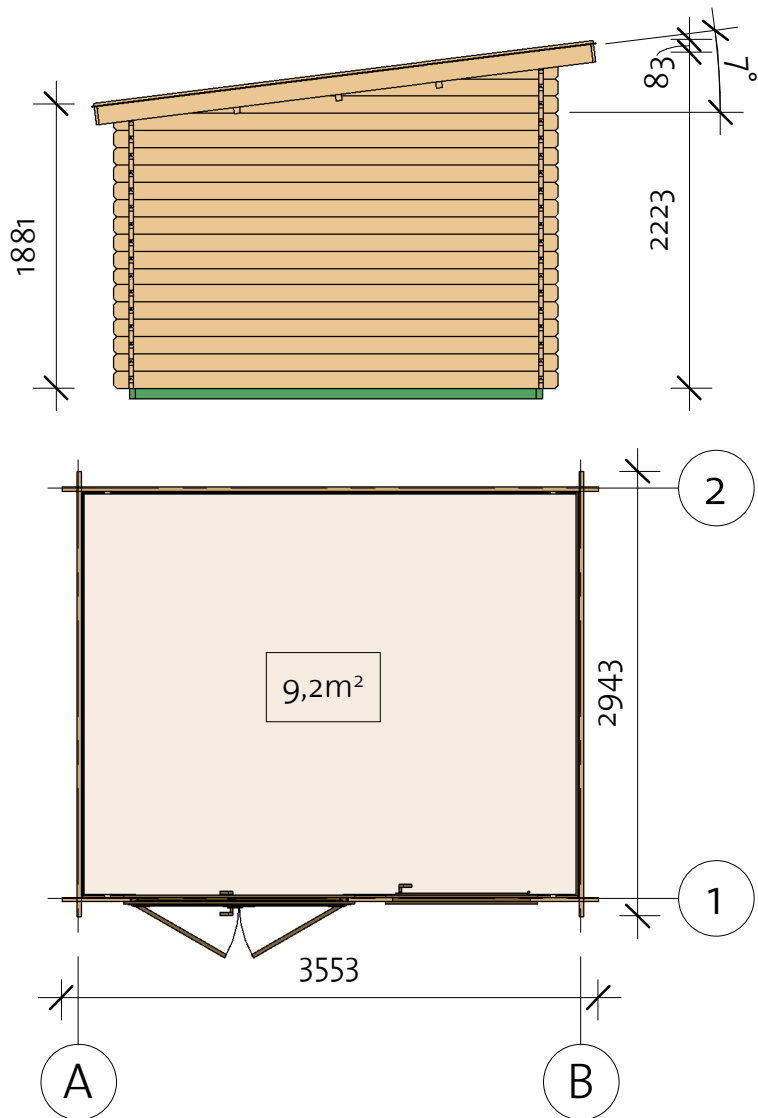

Carina 28 (335x274)

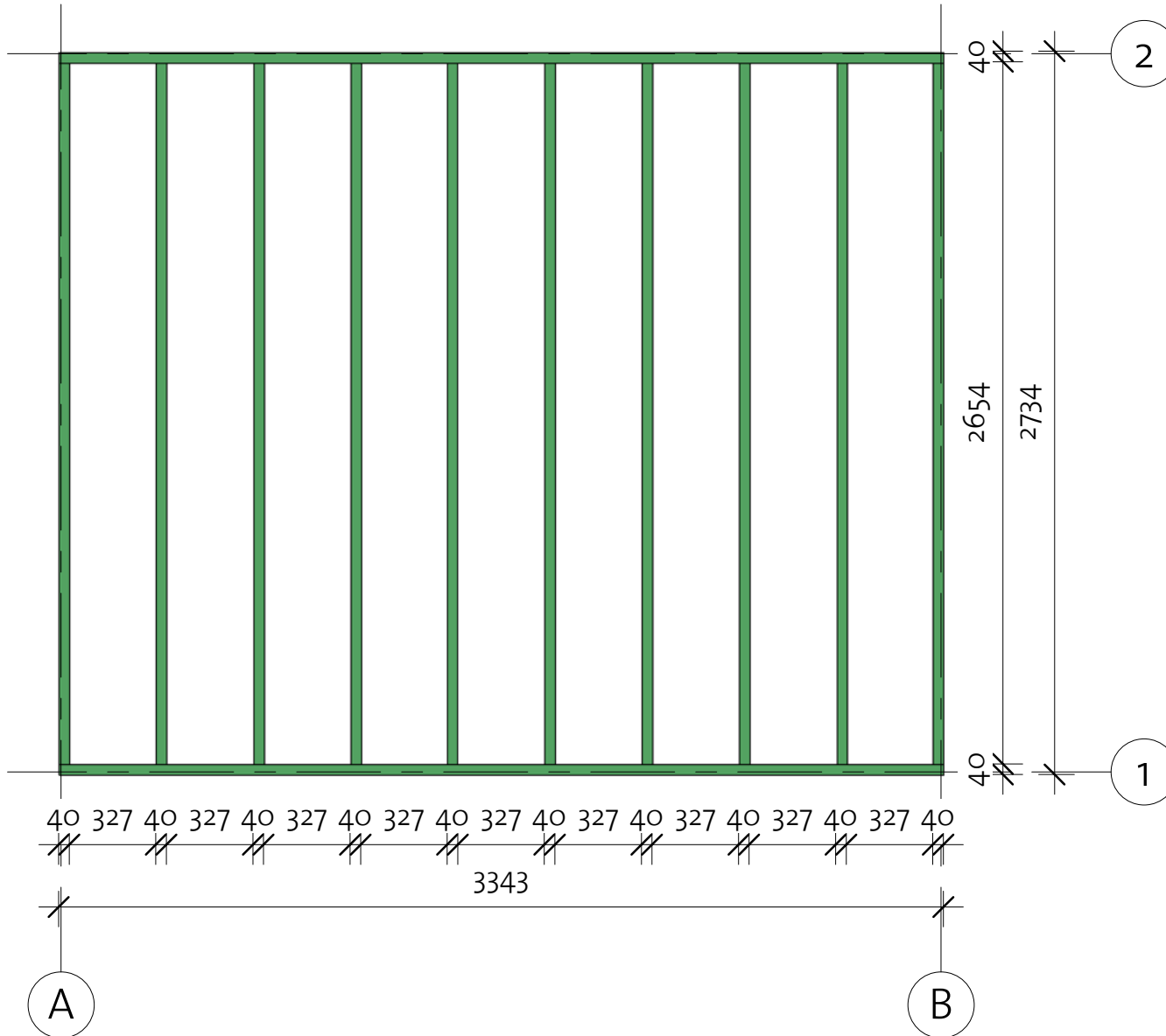

Carina 28 (335x274)

Foundation



Impregnated foundation beams				
Mark	Type	Profile	Count	Length
IFB1	IFB 40x70		10	2654
IFB2	IFB 40x70		2	3343



Carina 28 (335x274)

Floor Plan

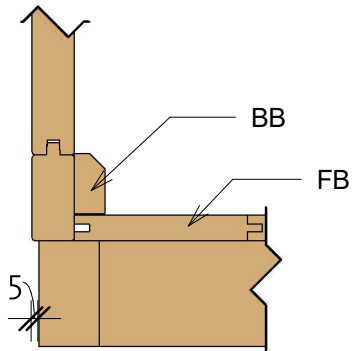
① Baseboard



Floor Schedule

Mark	Type	Profile	Count	Length
FB	FB 17x114		25	3295
BB1	BB 20x40		2	2800
BB2	BB 20x40		2	3400

4000009_200211

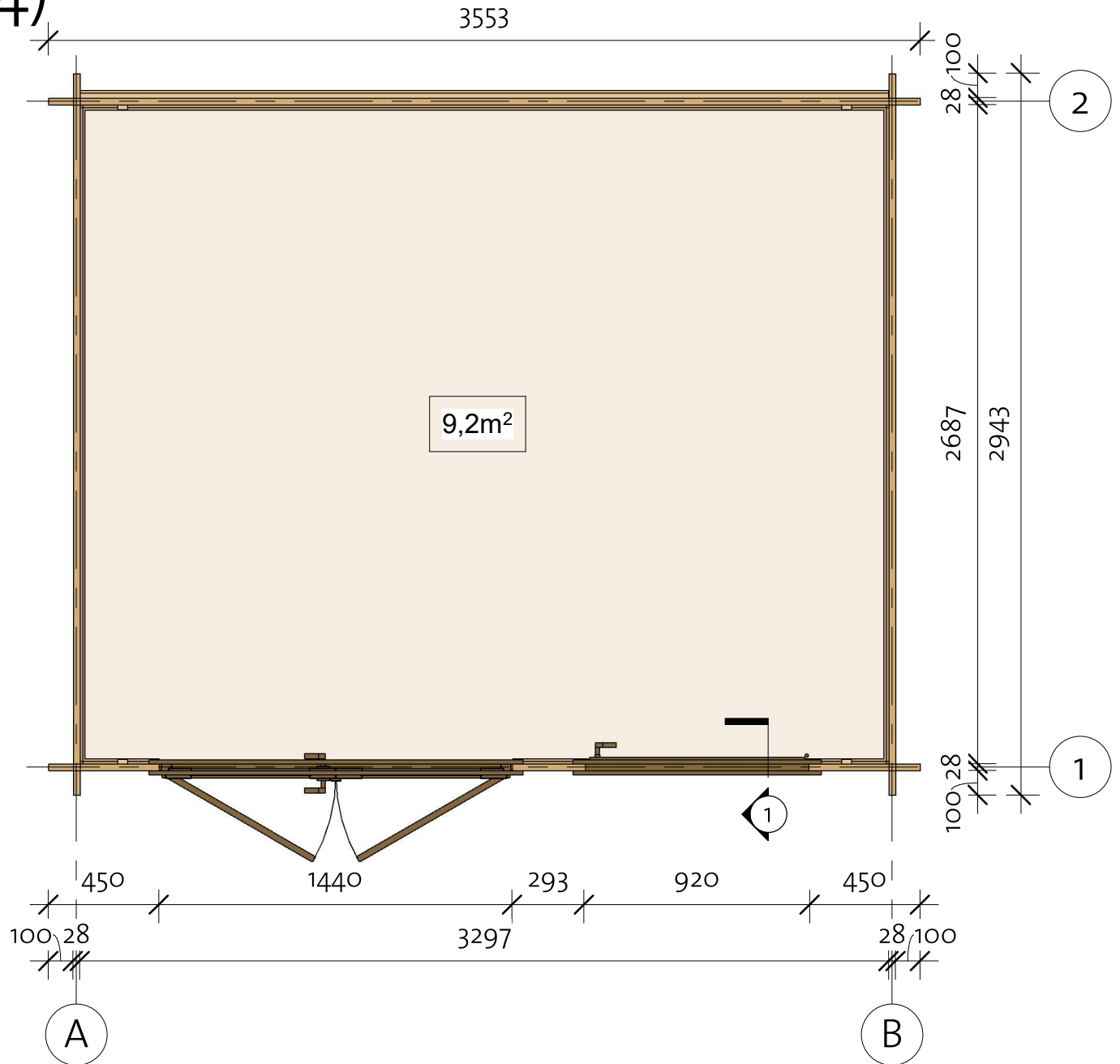

Carina 28 (335x274)

Wall 1

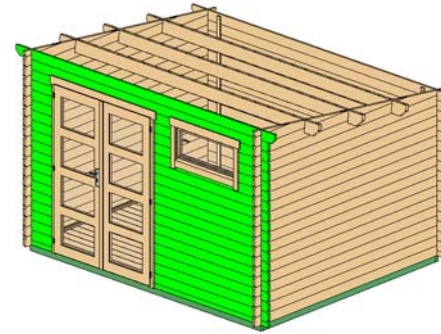

Wall 1			
Mark	Profile	Count	Cut Length

1BL 1	28x57	1	450
1BL 2	28x57	1	1663
1LG 1	28x114	4	293
1LG 2	28x114	21	450
1LG 3	28x114	13	1663
1LG 4	28x114	1	3553
1TL 1	28x114	1	3753

Log Profile Wall 1	
Profile	Profile

28x57	
28x114	
28x114	

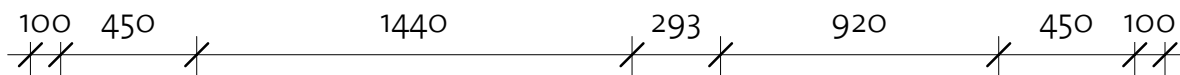
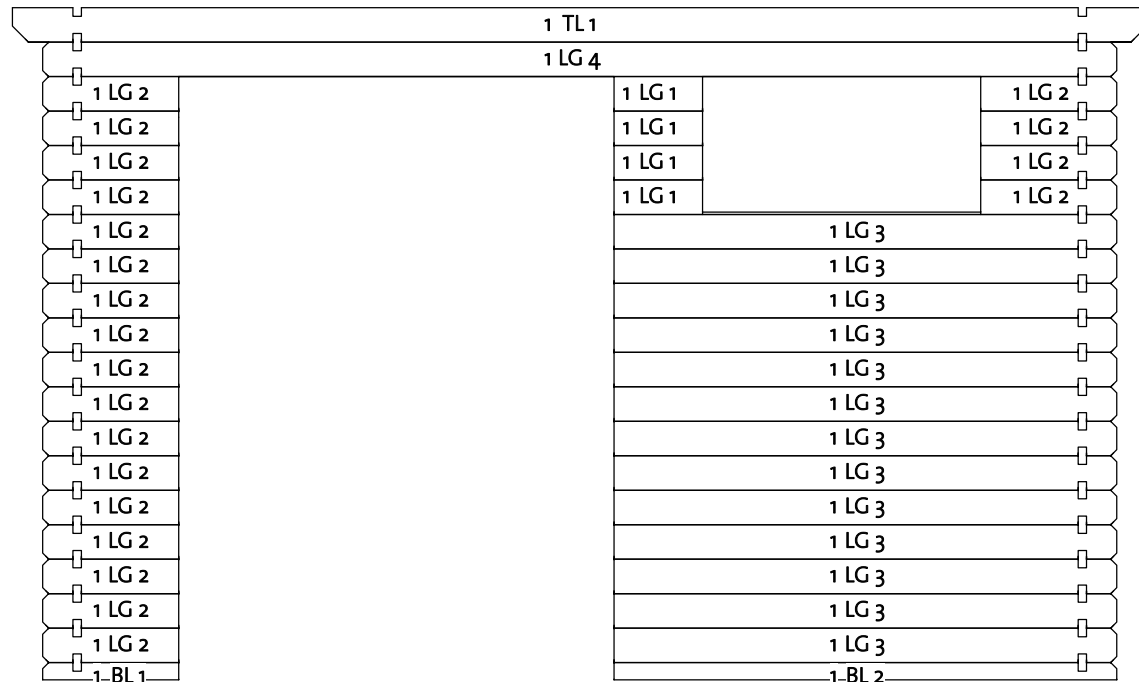

Carina 28 (335x274)

Wall 2

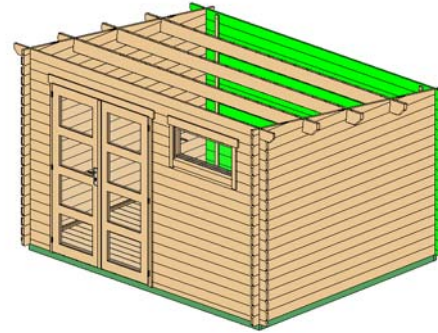

Wall 2			
Mark	Profile	Count	Cut Length

2BL 1	28x57	1	3553
2LG 1	28x114	15	3553
2TL 1	28x114	1	3753

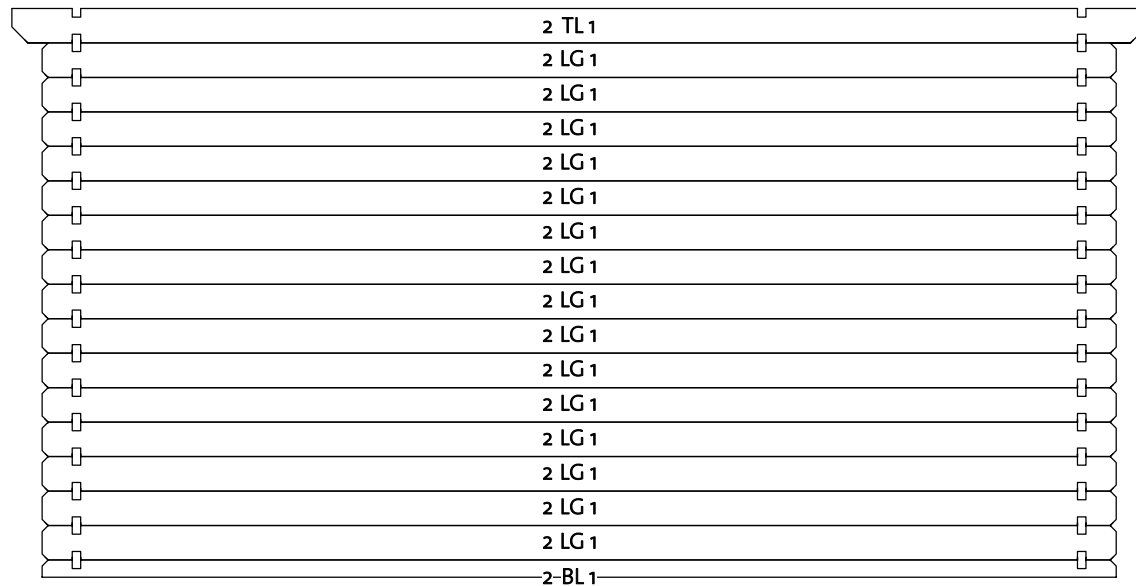

100
//

3553

100
//

Log Profile Wall 2	
Profile	Profile

28x57	
28x114	
28x114	

Carina 28 (335x274)

Wall A

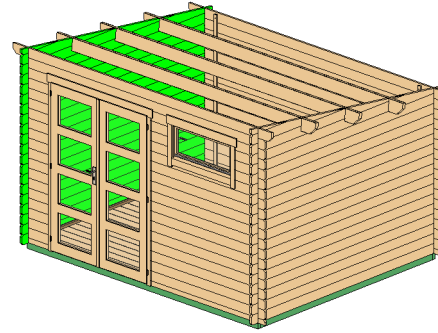

Wall A			
Mark	Profile	Count	Cut Length

ALG 1 *	28x114	1	551
ALG 2 *	28x114	1	1453
ALG 3 *	28x114	1	2362
ALG 4 *	28x114	1	2943
ALG 5	28x114	16	2943

* Gable - delivered premounted

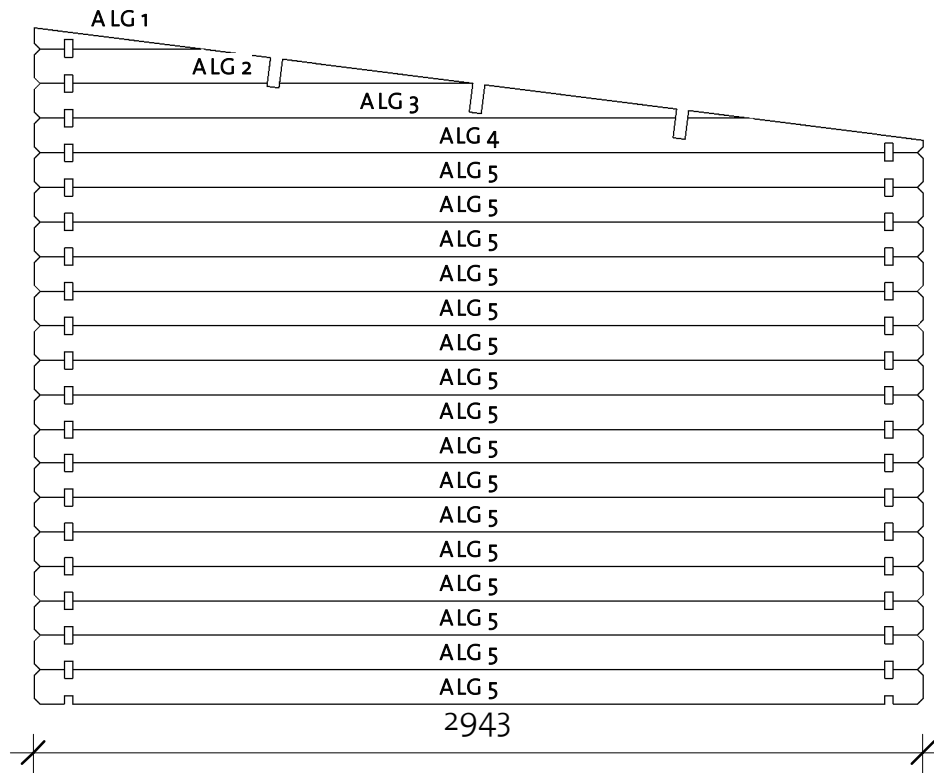

Log Profile Wall A	
Profile	Profile

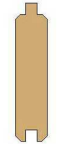
28x114	
--------	---

Carina 28 (335x274)

Wall B

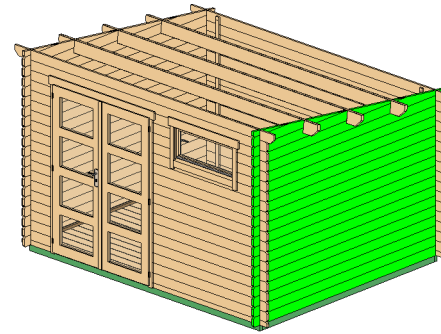

Wall B			
Mark	Profile	Count	Cut Length

BLG 1 *	28x114	1	551
BLG 2 *	28x114	1	1453
BLG 3 *	28x114	1	2362
BLG 4 *	28x114	1	2943
BLG 5	28x114	16	2943

* Gable - delivered premounted

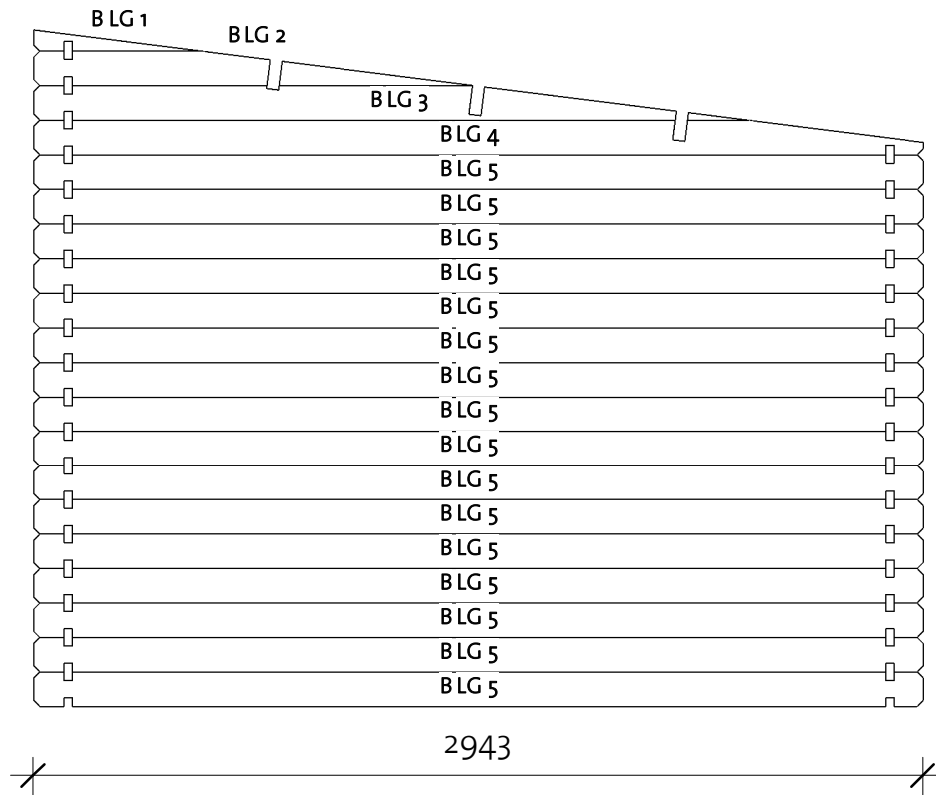



Log Profile Wall B	
Profile	Profile

28x114	
--------	--

Carina 28 (335x274)

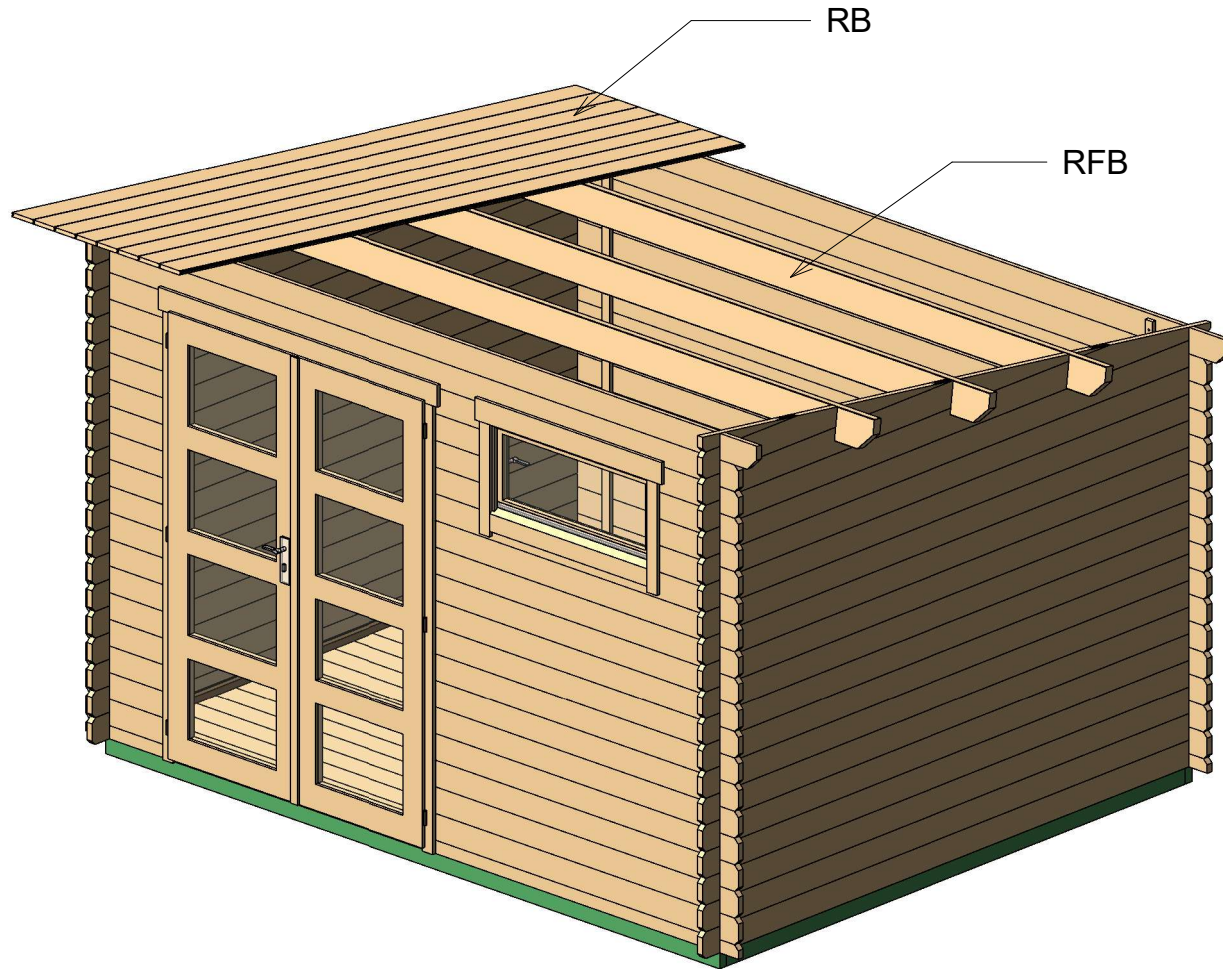
Roof 1



Roof				
Mark	Type	Profile	Count	Length
RFB	Beam 40x143		3	3753
RB	17x114		34	3295

Carina 28 (335x274)

Roof 2

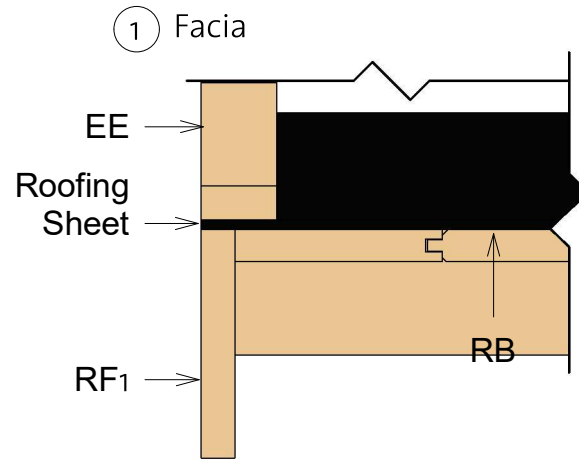
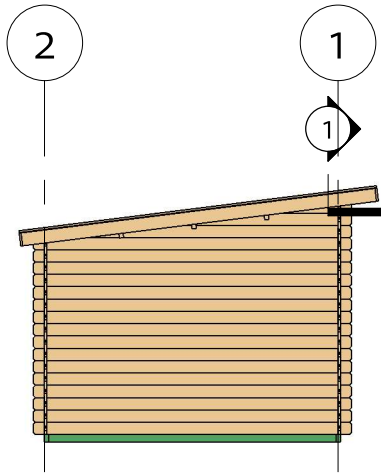



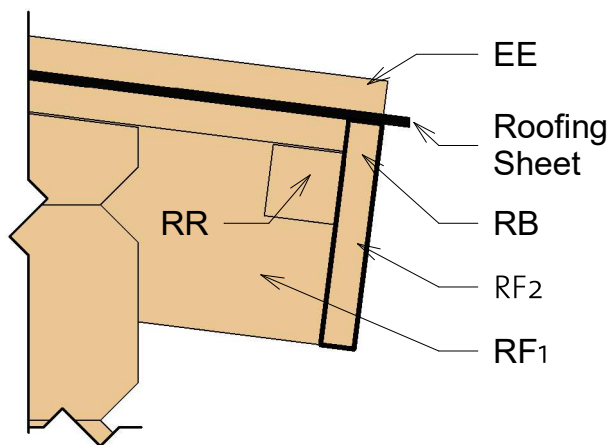
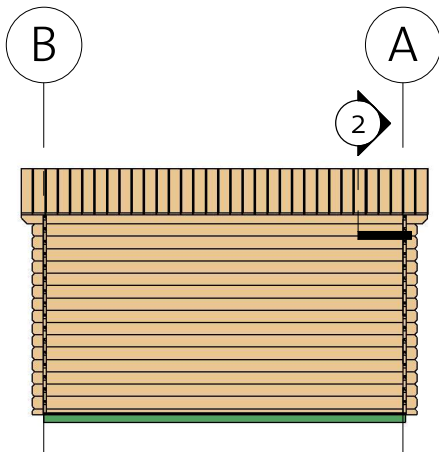



















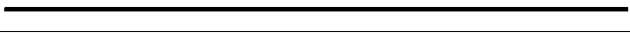





2 Roof Reinforcement



Fascia Schedule				
Mark	Type	Profile	Count	Length
EE	Eave Edging 18x40		2	3331
RF1	Roof Fascia 18x120		2	3295
RF2	Roof Fascia 18x120		2	3789
RR	Roof reinforcement 38x38		2	3753

Carina 28 (335x274)



List of all items 1

	RFB	Beam 40x143			3	3753
1	TL 1	Log 28x114			1	3753
2	TL 1	Log 28x114			1	3753
2	BL 1	Log 28x57			1	3553
2	LG 1	Log 28x114			15	3553
1	LG 4	Log 28x114			1	3553
	IFB2	IFB 40x70			2	3343
	FB	FB 17x114			25	3295
	RB	17x114			34	3295
A	LG 4	Log 28x114			1	2943
B	LG 4	Log 28x114			1	2943
A	LG 5	Log 28x114			16	2943
B	LG 5	Log 28x114			16	2943
	IFB1	IFB 40x70			10	2654
A	LG 3	Log 28x114			1	2362
B	LG 3	Log 28x114			1	2362
1	BL 2	Log 28x57			1	1663
1	LG 3	Log 28x114			13	1663
A	LG 2	Log 28x114			1	1453
B	LG 2	Log 28x114			1	1453
A	LG 1	Log 28x114			1	551
B	LG 1	Log 28x114			1	551



4000009_200211

Carina 28 (335x274)

List of all items 2

1	BL 1	Log 28x57		1	450
1	LG 2	Log 28x114		21	450
1	LG 1	Log 28x114		4	293

Windboard 18x40		4	2200
-----------------	--	---	------

RF2	Roof Fascia 18x120		2	3789
RR	Roof reinforceme nt 38x38		2	3753
EE	Eave Edging 18x40		2	3331
RF1	Roof Fascia 18x120		2	3295





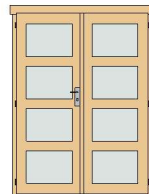

BB1	BB 20x40		2	2800
BB2	BB 20x40		2	3400

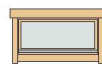
BDD4L	Basic double door 4, four glass left	1425	1955	1
-------	--	------	------	---



BW2L	Basic window 2, full glass left	915	420	1
------	--	-----	-----	---



Hitblock	300-400 mm		
Bolts	M8 x 60		12
Screws	5,0 x 70		15
Nails	1,4 x 40		30
Screws	6,0 x 140		60
Screws	4,0 x 40		70
Screws	4,0 x 50		500

4000009_200211