

Boden I 40 (361x277) - pärlin 68

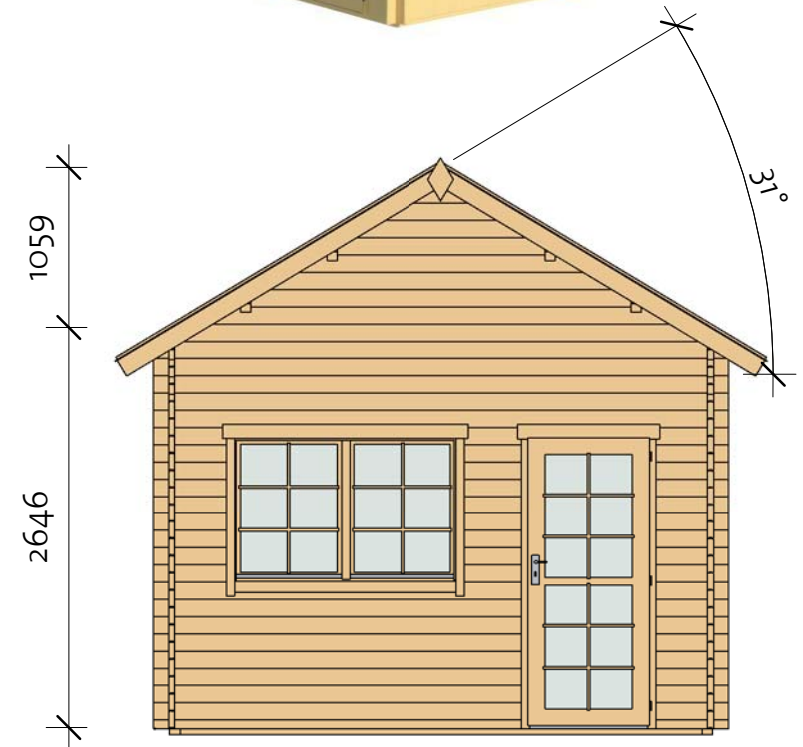

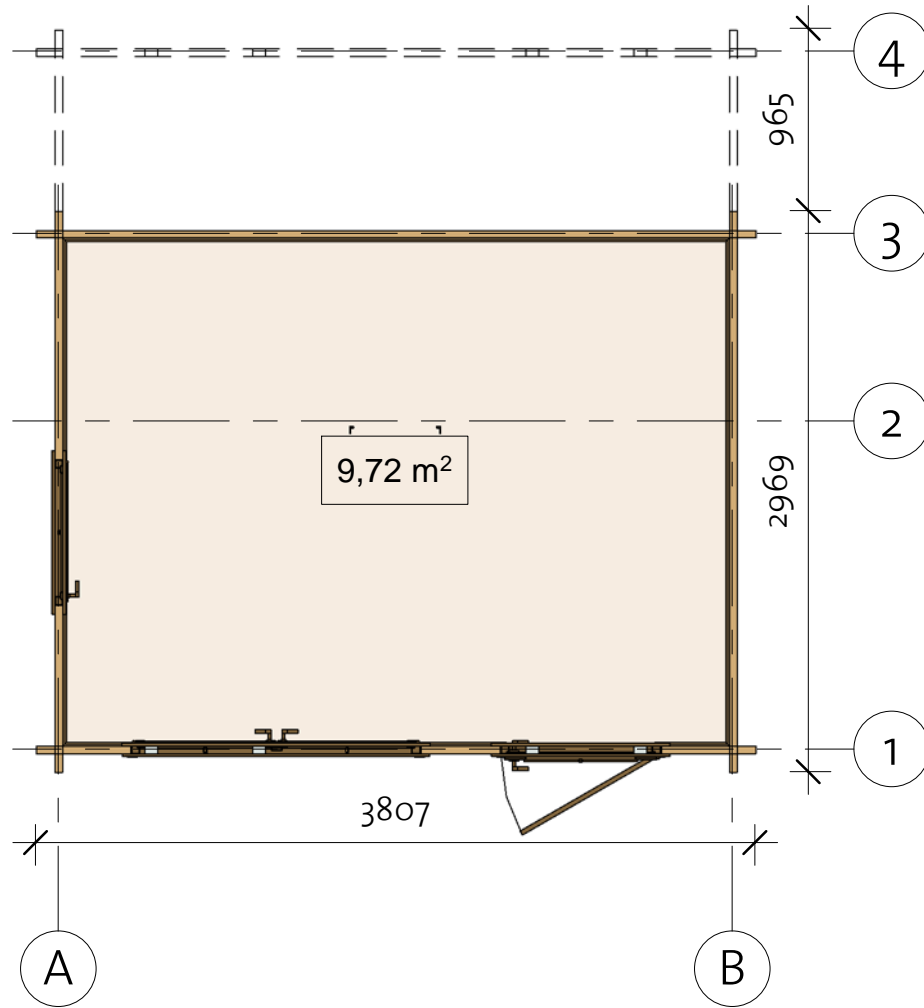
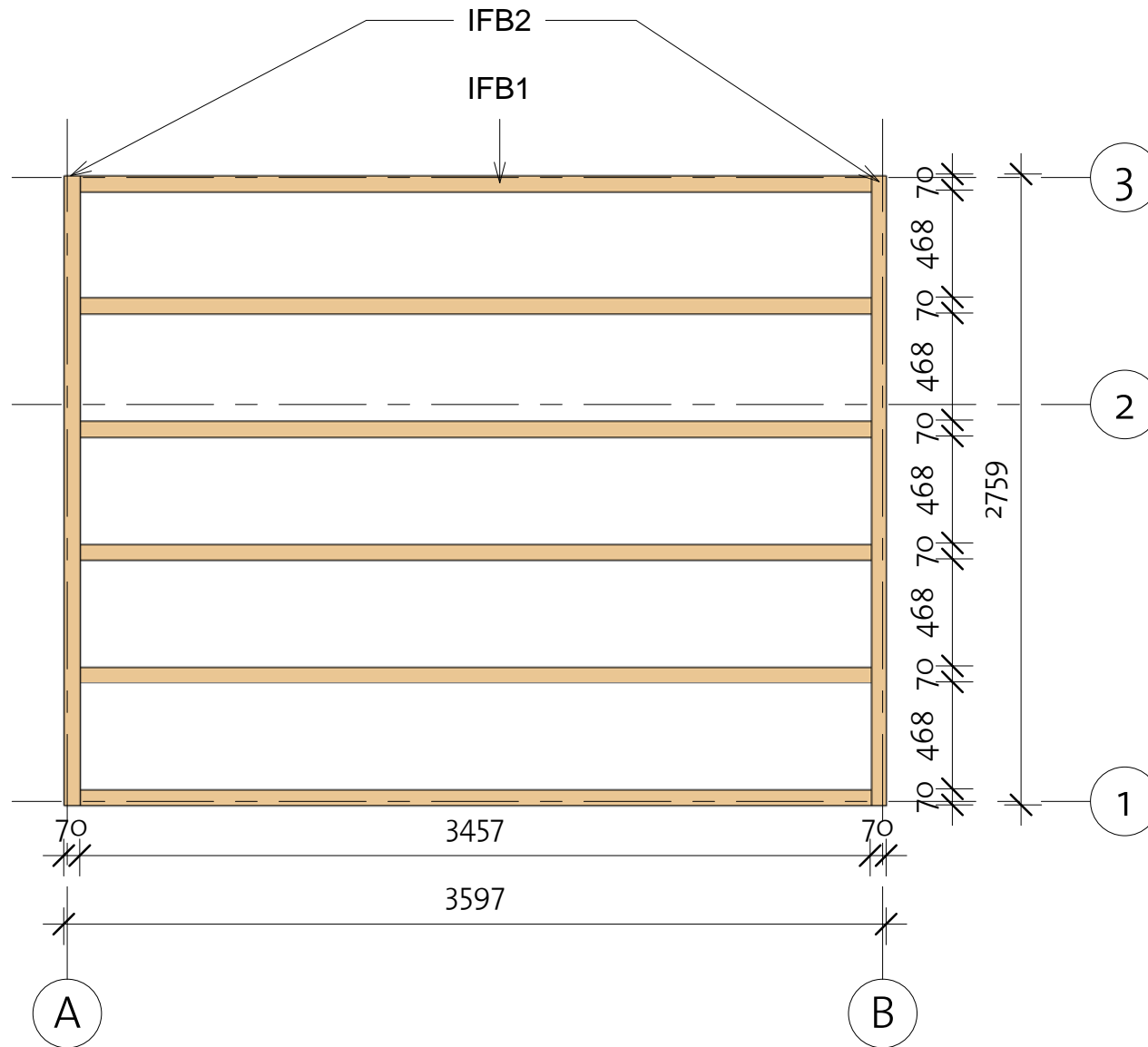

Boden I 40 (361x277) - pärlin 68

Foundation



Impregnated foundation beams				
Mark	Type	Profile	Count	Length



IFB1	IFB 40x70		6	3457
IFB2	IFB 40x70		2	2759

Boden I 40 (361x277) - pärlin 68

Floor Plan

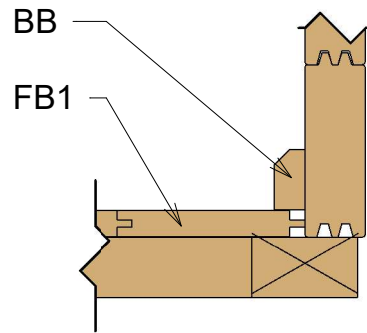
Ⓛ Baseboard



Floor Schedule				
Mark	Type	Profile	Count	Length
FB1	FB 17x114		32	2685
FB2	FB 17x114		32	1958
BB1	BB 20x40		2	1960
BB2	BB 20x40		2	2770
BB3	BB 20x40		3	3600

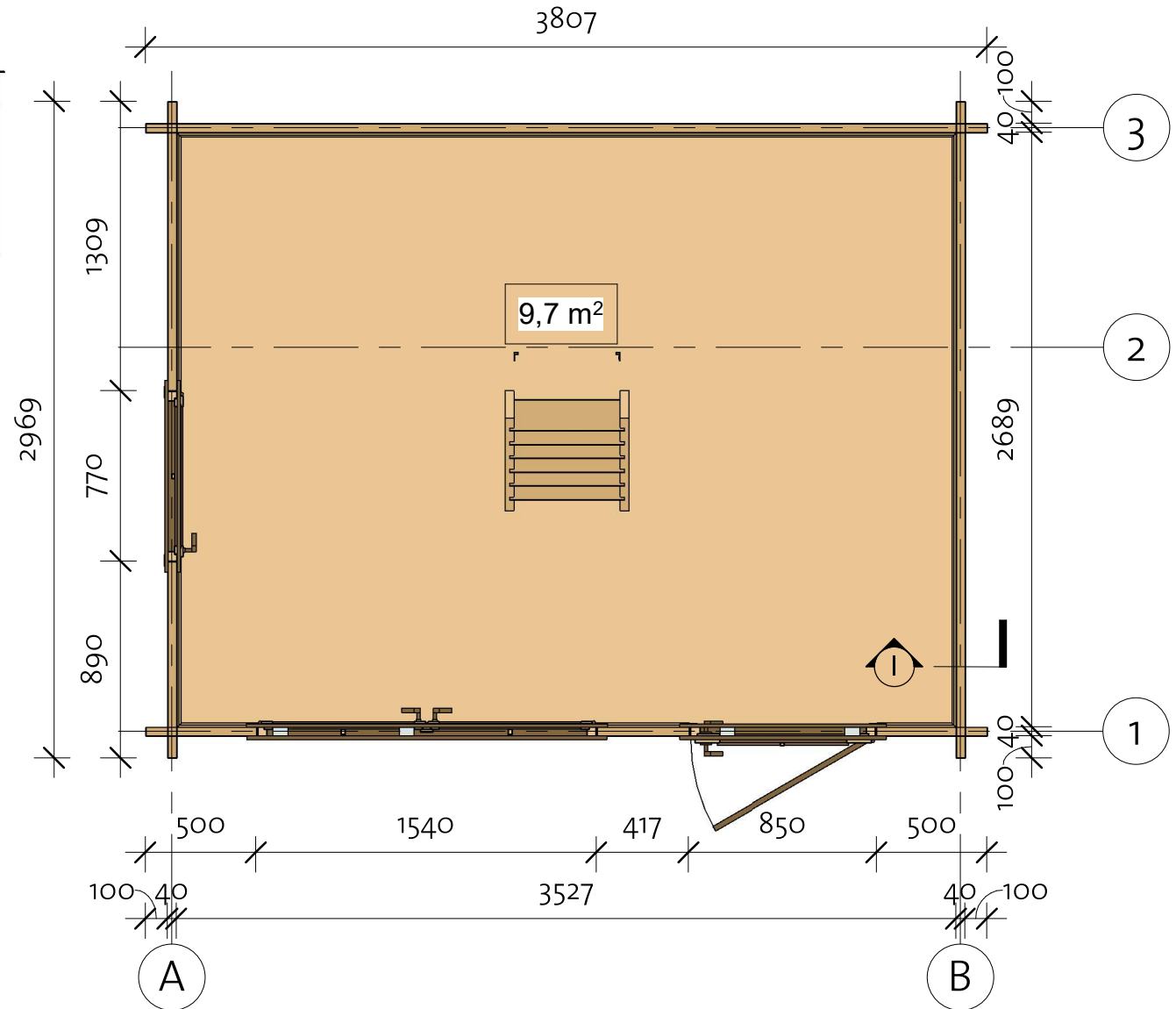

4200001_190910

Boden I 40 (361x277) - pärlin 68

Wall 1

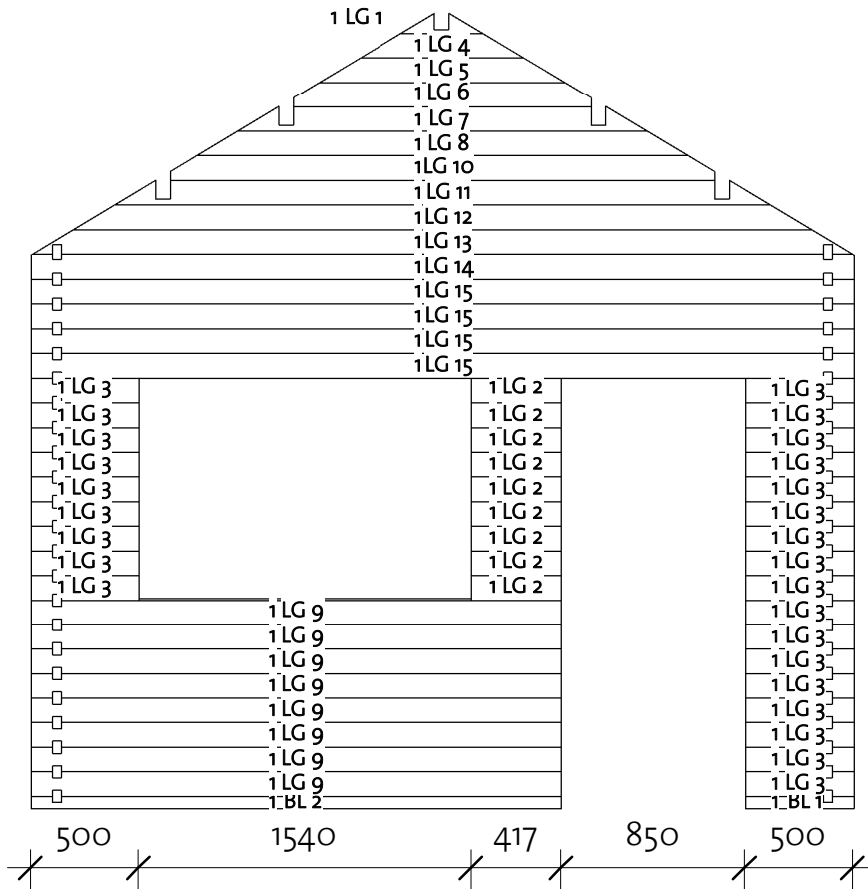
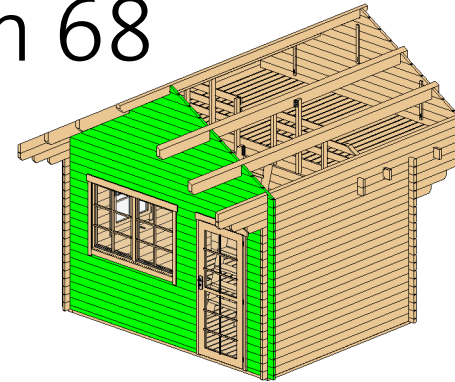

Log Profile Wall 1

Profile	Profile
---------	---------

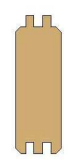
40x57	
40x114	

Wall 1			
Mark	Profile	Count	Cut Length

1BL 1	40x57	1	500
1BL 2	40x57	1	2457
1LG 1 *	40x114	1	379
1LG 2	40x114	9	417
1LG 3	40x114	26	500
1LG 4 *	40x114	1	759
1LG 5 *	40x114	1	1139
1LG 6 *	40x114	1	1380
1LG 7 *	40x114	1	1898
1LG 8 *	40x114	1	2278
1LG 9	40x114	8	2457
1LG 10 *	40x114	1	2520
1LG 11 *	40x114	1	3037
1LG 12 *	40x114	1	3417
1LG 13 *	40x114	1	3797
1LG 14 *	40x114	1	3807
1LG 15	40x114	4	3807

* Gable - delivered premounted

Boden I 40 (361x277) - pärlin 68

Wall 2

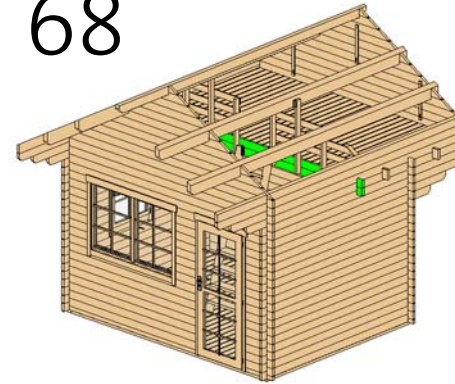

Wall 2			
Mark	Profile	Count	Cut Length

2LG-1	40x114	1	3807
2TL-1	40x114	1	3807

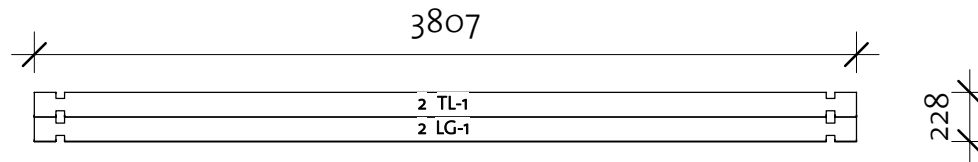

Log Profile Wall 2	
Profile	Profile

40X114	
40X114	

Boden I 40 (361x277) - pärlin 68

Wall 3

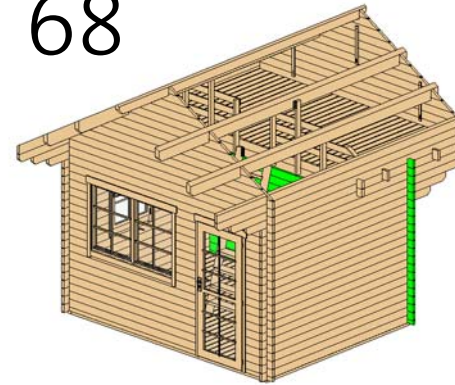

Wall 3			
Mark	Profile	Count	Cut Length

3BL 1	40x57	1	3807
3LG 1	40x114	19	3807
3TL 1	40x114	1	3807

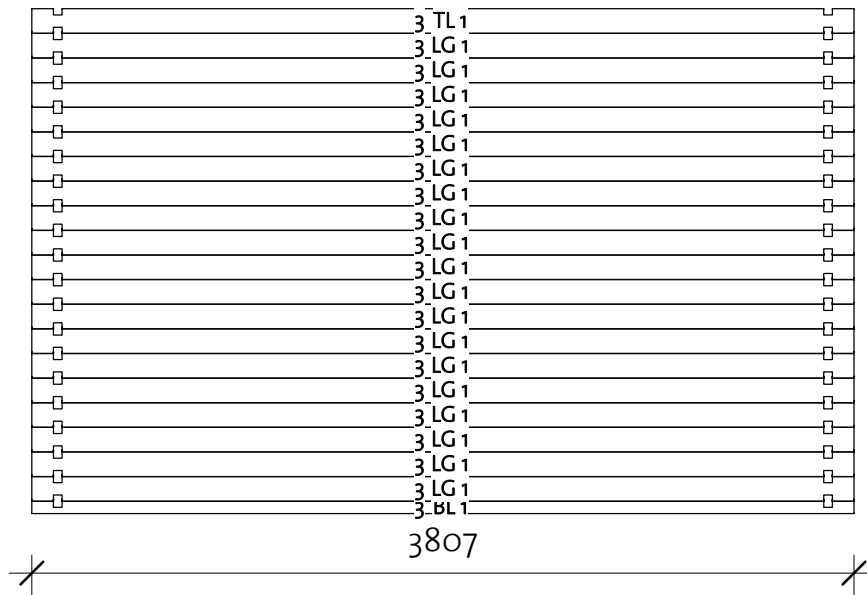

Log Profile Wall 3	
Profile	Profile

40x57	
40x114	
40x114	

Boden I 40 (361x277) - pärlin 68

Wall 4

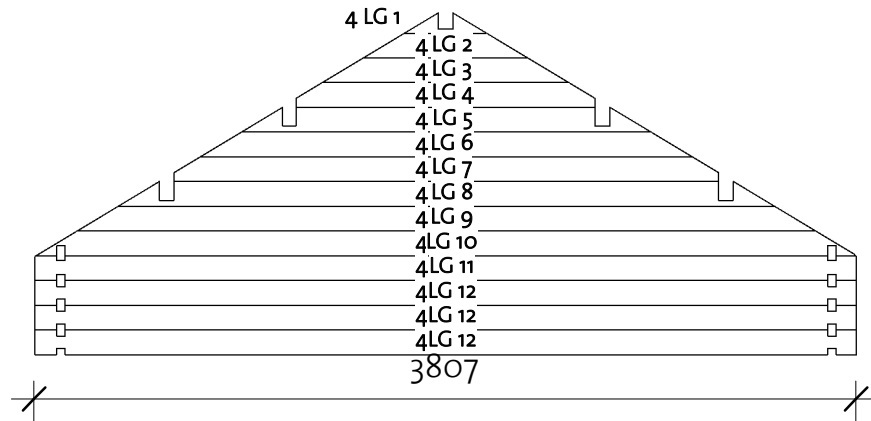
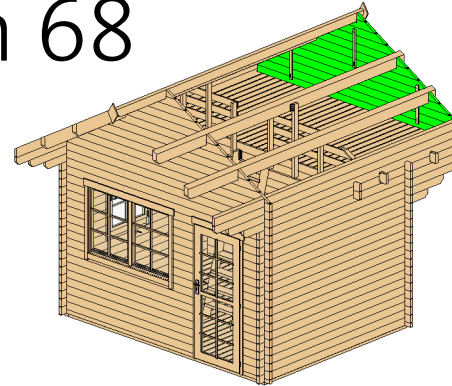

Wall 4			
Mark	Profile	Count	Cut Length

4LG 1 *	40x114	1	379
4LG 2 *	40x114	1	759
4LG 3 *	40x114	1	1139
4LG 4 *	40x114	1	1380
4LG 5 *	40x114	1	1898
4LG 6 *	40x114	1	2278
4LG 7 *	40x114	1	2520
4LG 8 *	40x114	1	3037
4LG 9 *	40x114	1	3417
4LG 10 *	40x114	1	3797
4LG 11 *	40x114	1	3807
4LG 12	40x114	3	3807

* Gable - delivered premounted

Log Profile Wall 4	
Profile	Profile

40x114	
--------	--

Boden I 40 (361x277) - pärlin 68

Wall A

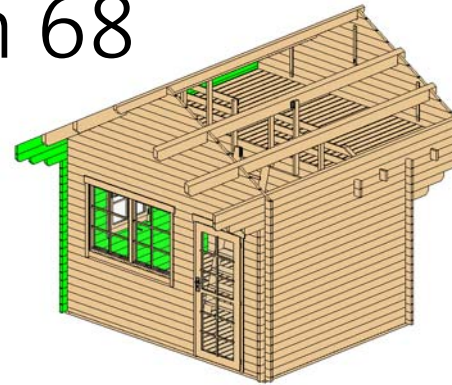

Wall A			
Mark	Profile	Count	Cut Length

ALG 1	40x114	9	890
ALG 2	40x114	7	1309
ALG 3	40x114	1	1609
ALG 4	40x114	8	2969
ALG 5	40x114	1	1909
ALG 6	40x114	1	3934
ALG 7	40x114	1	4234
ALG 8	40x114	1	4534
ALG 9	40x114	1	4800
ALG 10	40x114	1	3934
ATL 1	40x138	1	4800

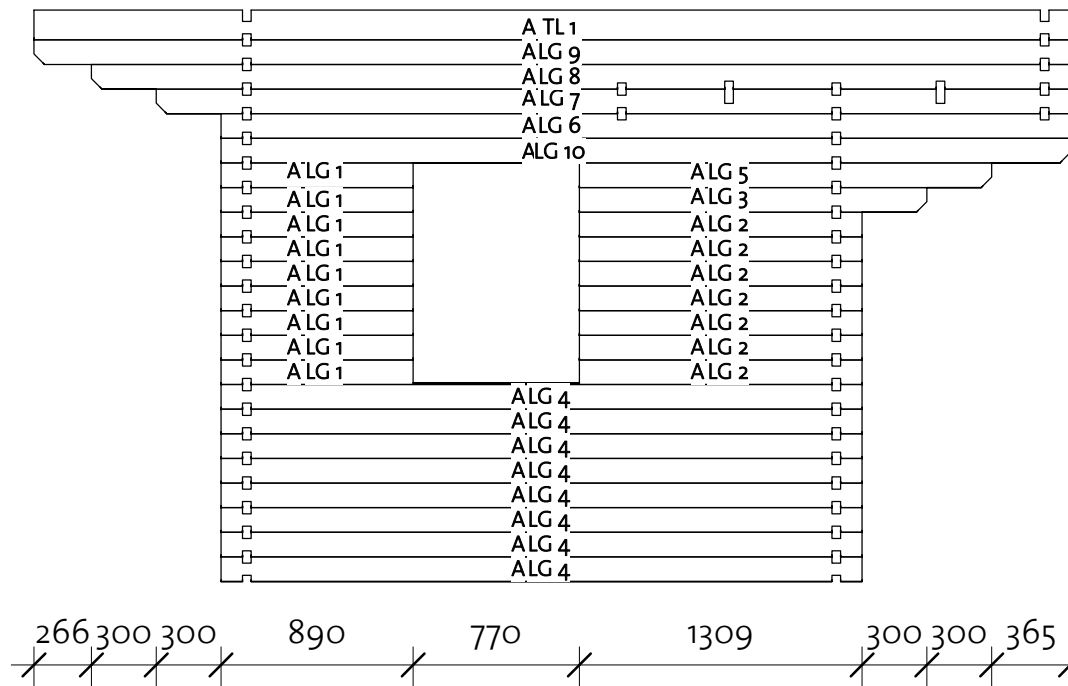

Log Profile Wall A	
Profile	Profile

40x114	
40x138	

Boden I 40 (361x277) - pärlin 68

Wall B

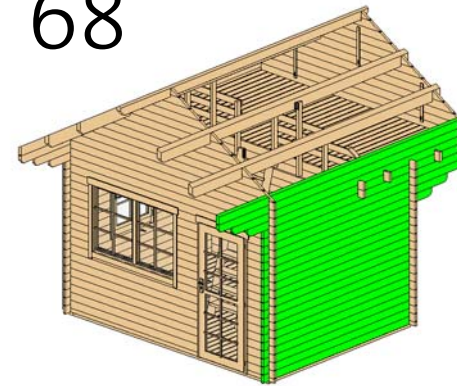

Wall B			
Mark	Profile	Count	Cut Length

BLG 1	40x114	15	2969
BLG 2	40x114	1	3269
BLG 3	40x114	1	3569
BLG 4	40x114	1	3934
BLG 5	40x114	1	3934
BLG 6	40x114	1	4234
BLG 7	40x114	1	4534
BLG 8	40x114	1	4800
BTL 1	40x138	1	4800

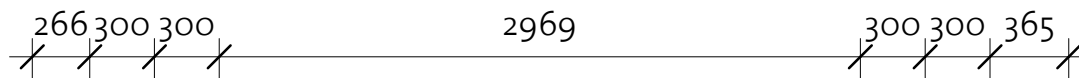
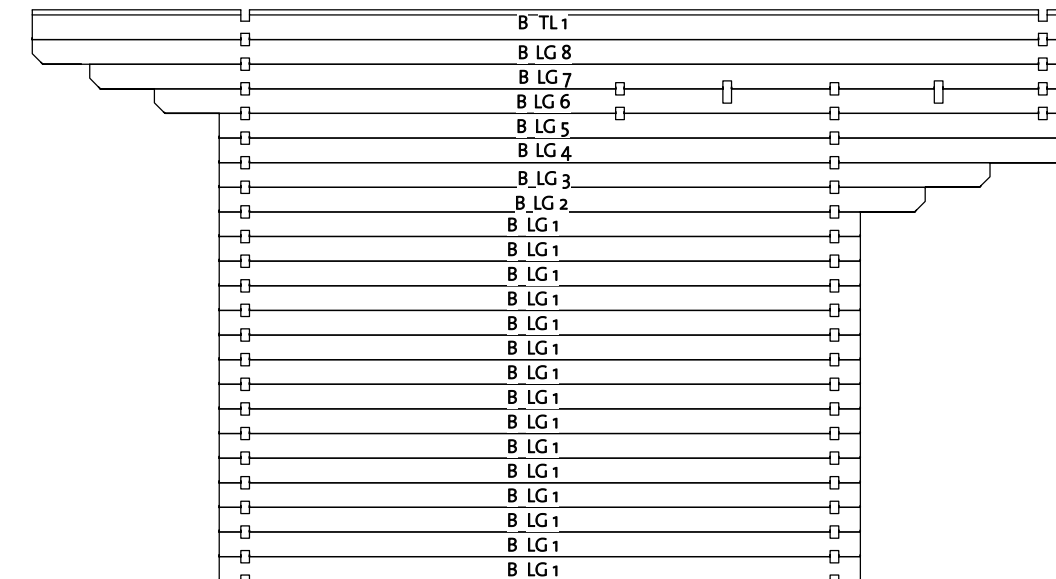





Log Profile Wall B	
Profile	Profile

40x114	
40x138	

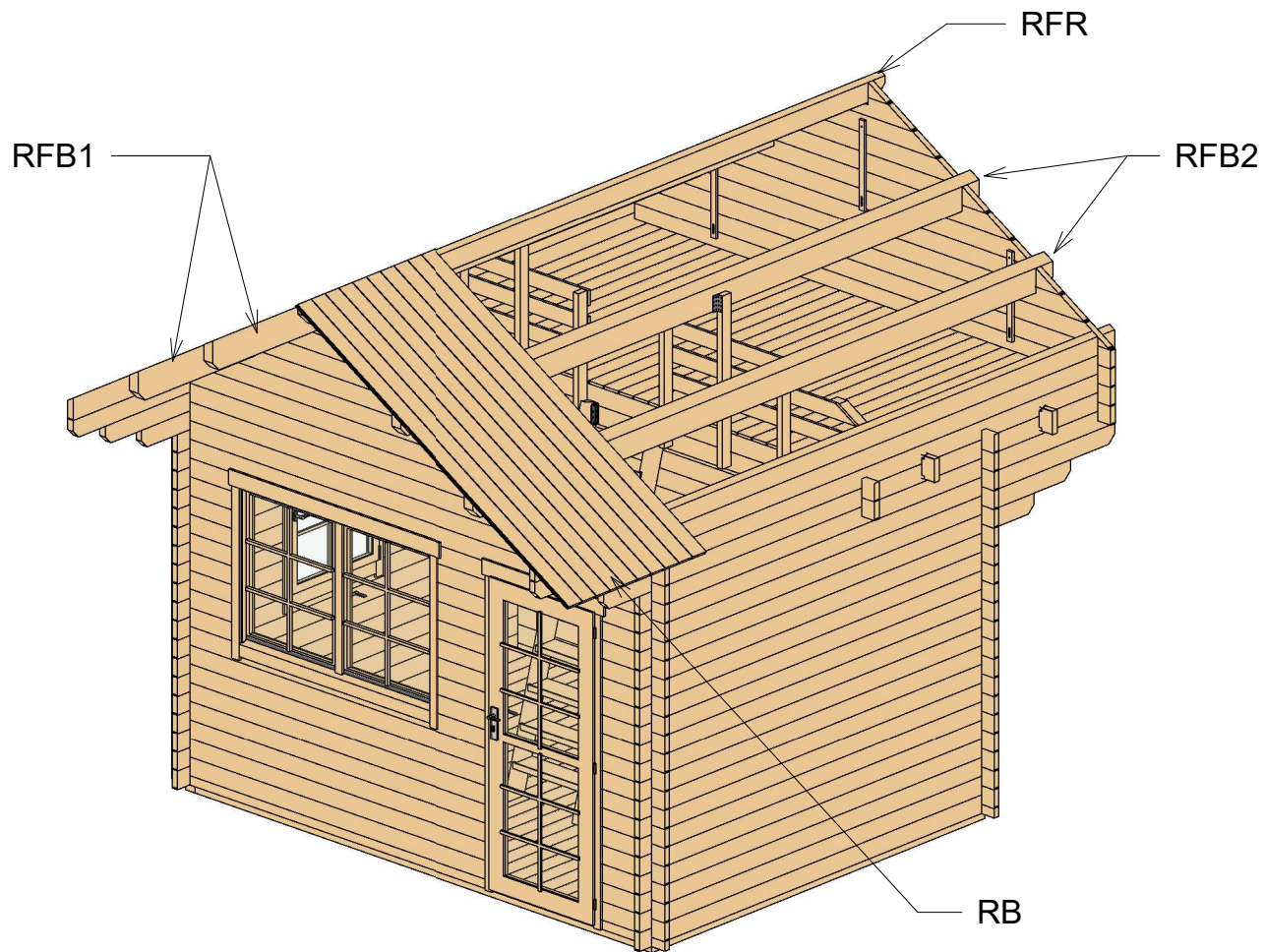
Boden I 40 (361x277) - pärlin 68

Roof 1



Roof				
Mark	Type	Profile	Count	Length
RFR	Ridge 68x143		1	4800
RFB1	Beam 68x193		2	4800
RFB2	Beam 68x193		2	4800
RB	17x114		86	2450

Boden I 40 (361x277) - pärlin 68

Roof 2

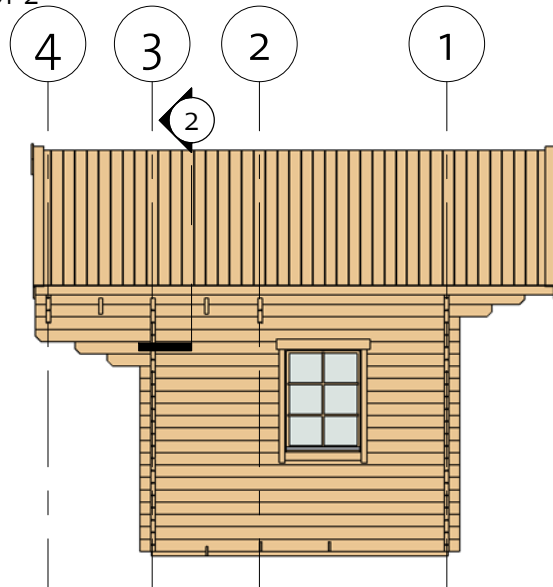

② Facia

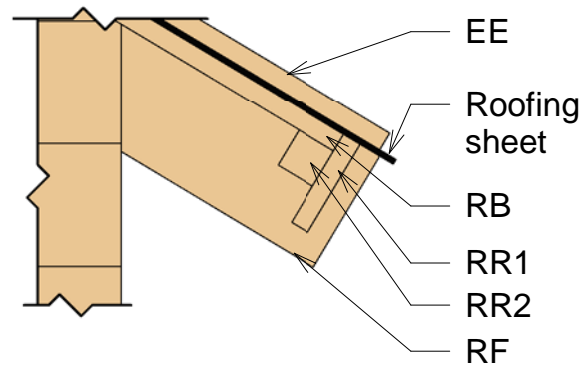

③ Roof Reinforcement

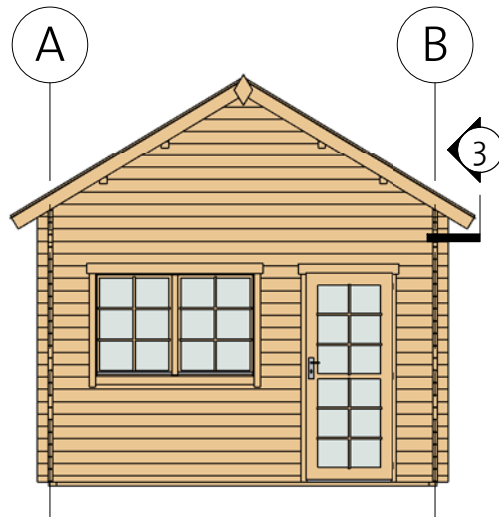
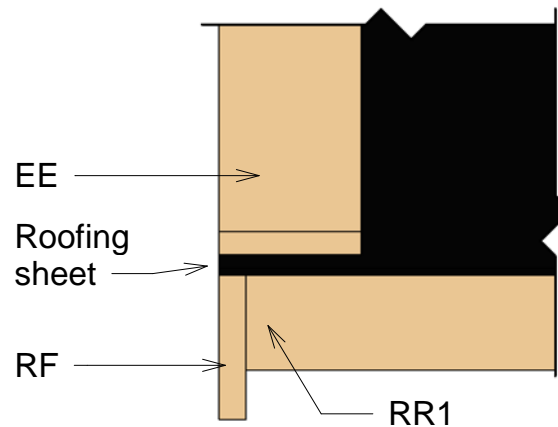

Fascia Schedule				
Mark	Type	Profile	Count	Length
EE	Eave Edging 18x95		4	2500
RF	Roof Fascia 18x120		4	2500
RR1	Roof reinforcement 18x95		2	4800
RR2	Roof reinforcement 38x38		2	4800

Boden I 40 (361x277) - pärlin 68

Second floor

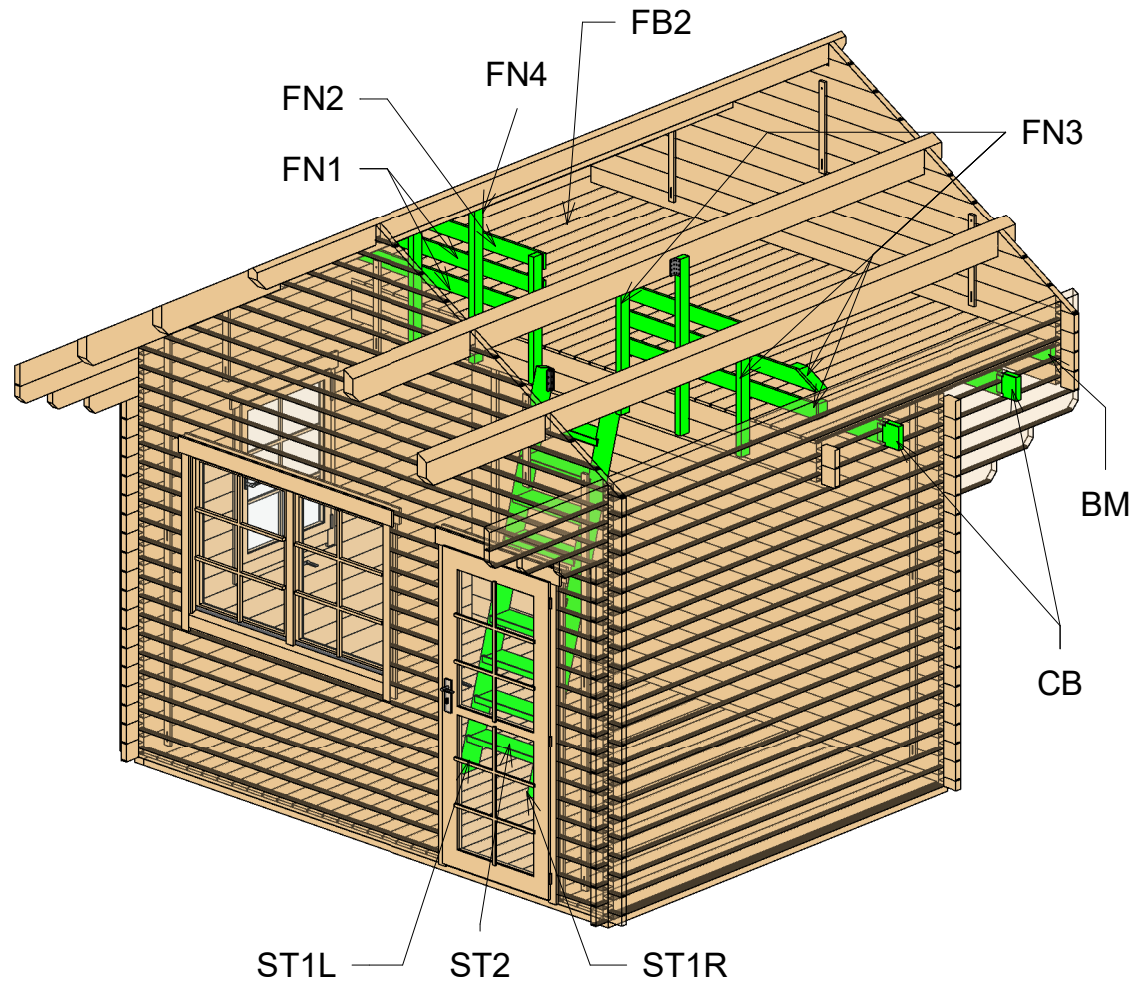

* Stair location can be chosen, Fence details supplied in full length, recommended installation method shown in the assembly guide.

4200001_190910

Second floor				
Mark	Type	Profile	Count	Cut Length
BM	Beam 40x90		1	3527
CB	Ceiling beam 40x143		2	3807
FN1	Fence1 18x95		2	3600
FN2	Fence2 18x95		1	2600
FN3	Fence3 40x70		5	762
FN4	Fence4 40x70		2	1055
ST1L	Stair 40x120 L		1	2333
ST1R	Stair 40x120 R		1	2333
ST2	Stair 143x40		9	520

Boden I 40 (361x277) - pärlin 68

Fence

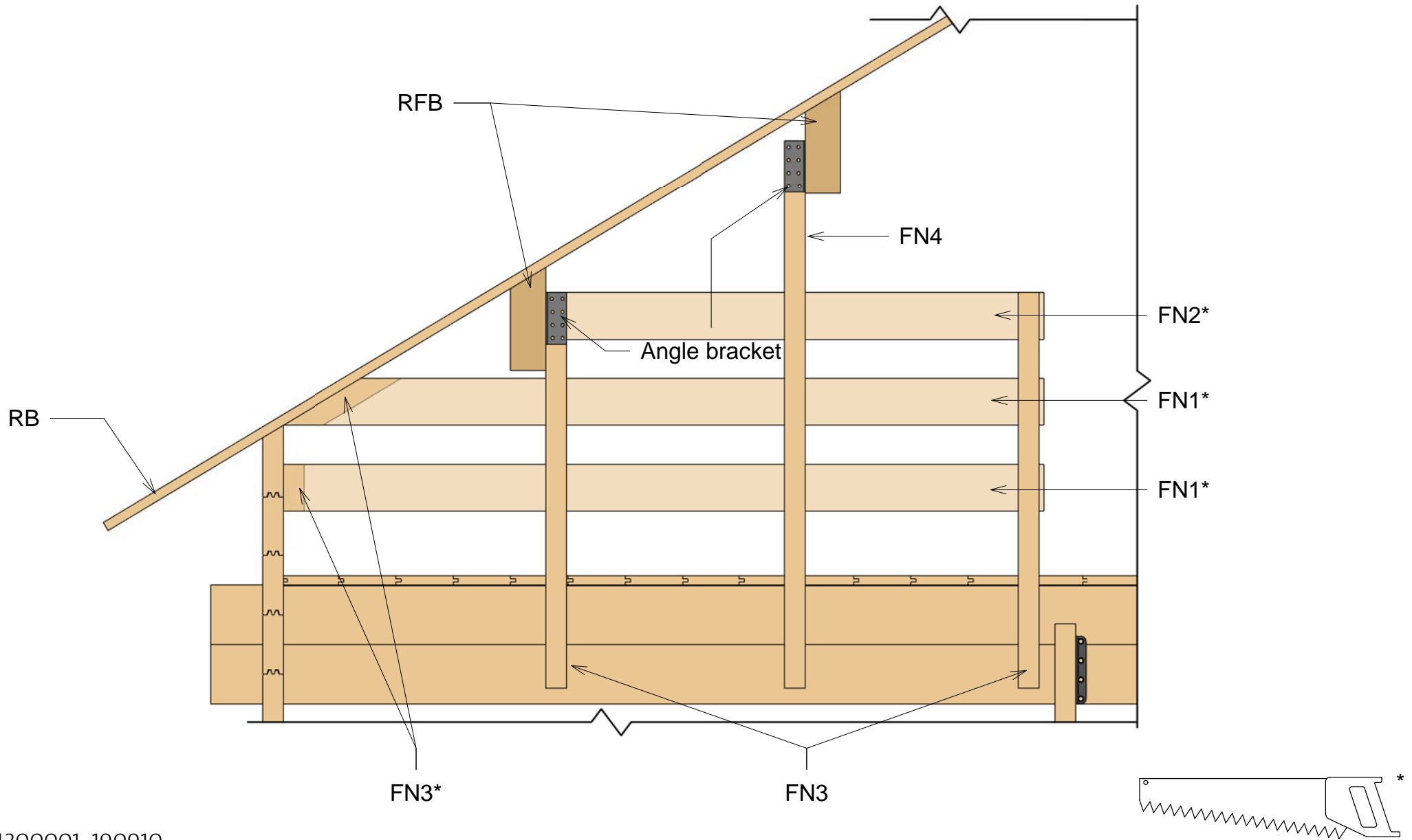

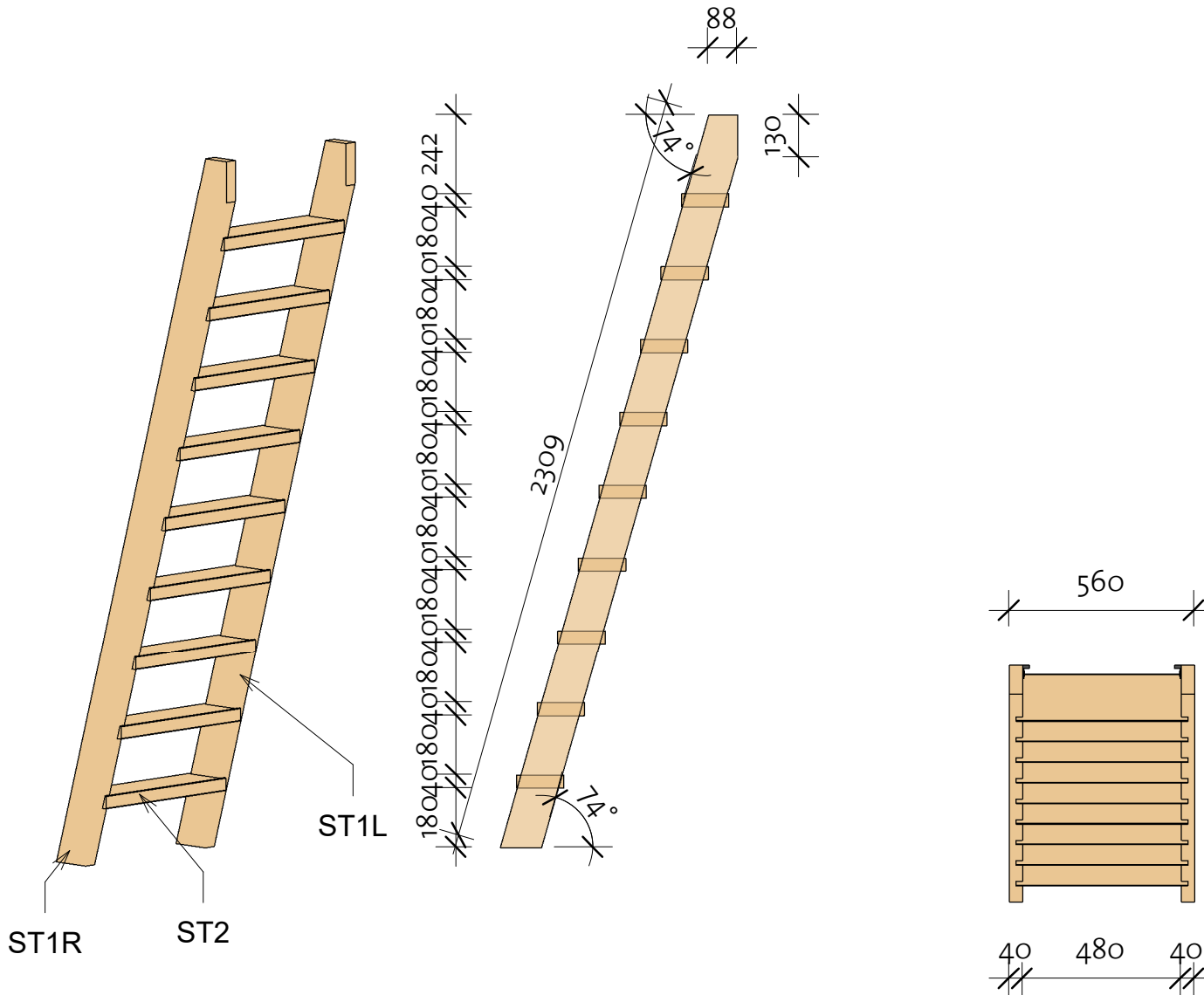

Boden I 40 (361x277) - pärlin 68

Stair



4200001_190910

Stair				
Mark	Profile	Profile	Count	Cut Length
ST1L	Stair 40X120		1	2333
ST1R	Stair 40X120		1	2333
ST2	Stair 143X40		9	520

Boden I 40 (361x277) - pärlin 68

Extras

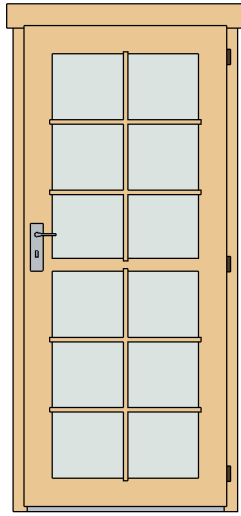

Door Schedule				
Model	Type	Width	Height	Count
CD3R	Classic door 3, two glass right	840	1955	1
DCB6	Door Crossbar 6	--	--	2

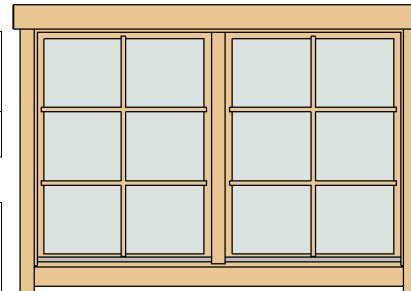

Window Schedule				
Model	Type	Width	Height	Count
CDW1	Classic double window 1	1530	990	1
CW1R	Classic window 1 right	765	990	1
WCB6	Windows Crossbar 6	--	--	3

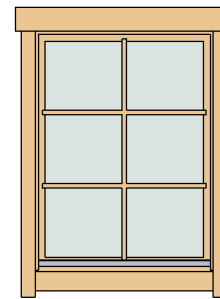

Fasteners/Extras		
Name	Type	Count

Hitblock	300-400 mm	
Ladder fittings		2
Angle bracket	30x40x100	4
Bolts	M8 x 70	24
Screws	5,0 x 40	24
Screws	5,0 x 70	60
Nails	1,4 x 40	60
Screws	6,0 x 140	90
Screws	4,0 x 40	230
Screws	4,0 x 50	800

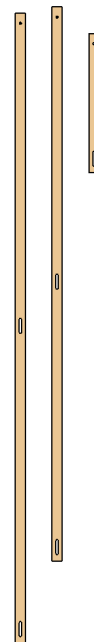

Type	Count	Length
Windboard 1 18x40	2	2500
Windboard 2 18x40	2	2200
Windboard 3 18x40	6	550

Family	Count
Romb	2





4200001_190910

Boden I 40 (361x277) - pärlin 68

List of all items 1



Impregnated foundation beams

Mark	Type	Profile	Count	Length
------	------	---------	-------	--------

IFB1	IFB 40x70		6	3457
IFB2	IFB 40x70		2	2759



Floor Schedule

Mark	Type	Profile	Count	Length
------	------	---------	-------	--------

FB1	FB 17x114		32	2685
FB2	FB 17x114		32	1958
BB1	BB 20x40		2	1960
BB2	BB 20x40		2	2770
BB3	BB 20x40		3	3600



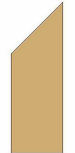
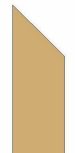

Roof

Mark	Type	Profile	Count	Length
------	------	---------	-------	--------

RFR	Ridge 68x143		1	4800
RFB1	Beam 68x193		2	4800
RFB2	Beam 68x193		2	4800
RB	17x114		86	2450

Fascia Schedule

Mark	Type	Profile	Count	Length
------	------	---------	-------	--------

EE	Eave Edging 18x95		4	2500
RF	Roof Fascia 18x120		4	2500
RR1	Roof reinforcement 18x95		2	4800
RR2	Roof reinforcement 38x38		2	4800

Boden I 40 (361x277) - pärlin 68

List of all items 2

Wall 1			
Mark	Profile	Count	Cut Length

1BL 1	40X57	1	500
1BL 2	40X57	1	2457
1LG 1 *	40X114	1	379
1LG 2	40X114	9	417
1LG 3	40X114	26	500
1LG 4 *	40X114	1	759
1LG 5 *	40X114	1	1139
1LG 6 *	40X114	1	1380
1LG 7 *	40X114	1	1898
1LG 8 *	40X114	1	2278
1LG 9	40X114	8	2457
1LG 10*	40X114	1	2520
1LG 11*	40X114	1	3037
1LG 12*	40X114	1	3417
1LG 13*	40X114	1	3797
1LG 14*	40X114	1	3807
1LG 15	40X114	4	3807

* Gable - delivered premounted



Wall 2			
Mark	Profile	Count	Cut Length

2LG-1	40X114	1	3807
2TL-1	40X114	1	3807

Wall 3			
Mark	Profile	Count	Cut Length

3BL 1	40X57	1	3807
3LG 1	40X114	19	3807
3TL 1	40X114	1	3807

Log Profiles 1	
Profile	Profile

40X57	
40X114	

Log Profiles 1	
Profile	Profile

40X114	
--------	---

Boden I 40 (361x277) - pärlin 68

List of all items 3

Wall 4			
Mark	Profile	Count	Cut Length

4LG 1 *	40X114	1	379
4LG 2 *	40X114	1	759
4LG 3 *	40X114	1	1139
4LG 4 *	40X114	1	1380
4LG 5 *	40X114	1	1898
4LG 6 *	40X114	1	2278
4LG 7 *	40X114	1	2520
4LG 8 *	40X114	1	3037
4LG 9 *	40X114	1	3417
4LG 10*	40X114	1	3797
4LG 11*	40X114	1	3807
4LG 12	40X114	3	3807

* Gable - delivered premounted

Log Profiles 2	
Profile	Profile

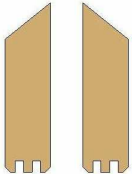
40X114	
40X138	

Wall A			
Mark	Profile	Count	Cut Length









ALG 1	40X114	9	890
ALG 2	40X114	7	1309
ALG 3	40X114	1	1609
ALG 4	40X114	8	2969
ALG 5	40X114	1	1909
ALG 6	40X114	1	3934
ALG 7	40X114	1	4234
ALG 8	40X114	1	4534
ALG 9	40X114	1	4800
ALG 10	40X114	1	3934
ATL 1	40X138	1	4800

Wall B			
Mark	Profile	Count	Cut Length

BLG 1	40X114	15	2969
BLG 2	40X114	1	3269
BLG 3	40X114	1	3569
BLG 4	40X114	1	3934
BLG 5	40X114	1	3934
BLG 6	40X114	1	4234
BLG 7	40X114	1	4534
BLG 8	40X114	1	4800
BTL 1	40X138	1	4800

Boden I 40 (361x277) - pärlin 68

List of all items 4

Second floor				
Mark	Type	Profile	Count	Cut Length
BM	Beam 40x90		1	3527
CB	Ceiling beam 40x143		2	3807
FN1	Fence1 18x95		2	3600
FN2	Fence2 18x95		1	2600
FN3	Fence3 40x70		5	762
FN4	Fence4 40x70		2	1055
ST1L	Stair 40x120 L		1	2333
ST1R	Stair 40x120 R		1	2333
ST2	Stair 143x40		9	520