

DM 160 | DM 140 | DM 120

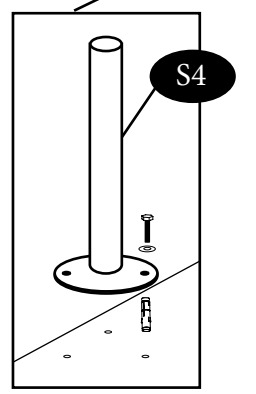

9	10	11	12	13	
1980	2200	2420	2640	2860	mm
-	-	-	-	-	
2142	2380	2618	2856	3094	mm
232°	258°	284°	310°	336°	
236°	262°	288°	314°	340°	
205°	228°	251°	273°	296°	

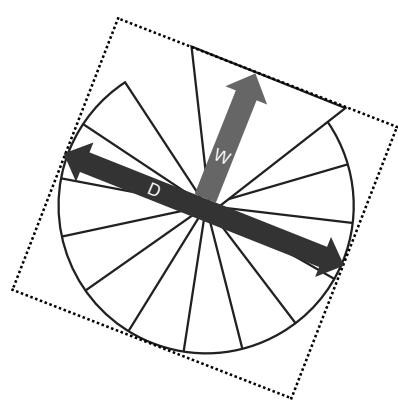

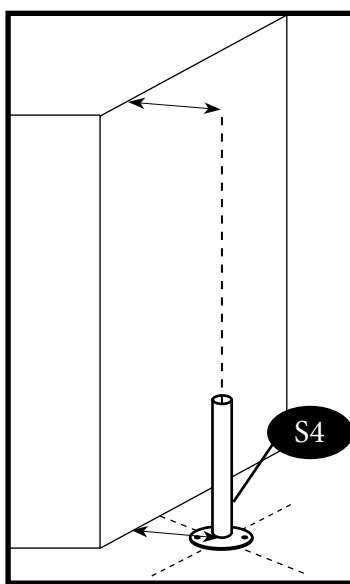
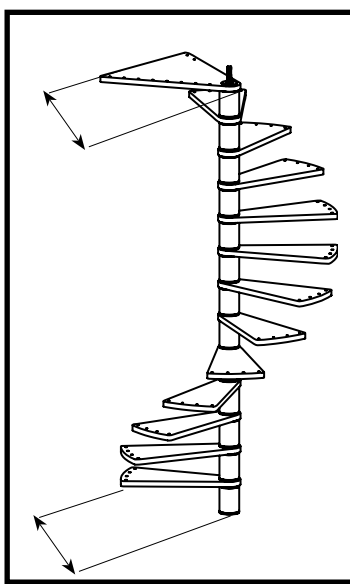
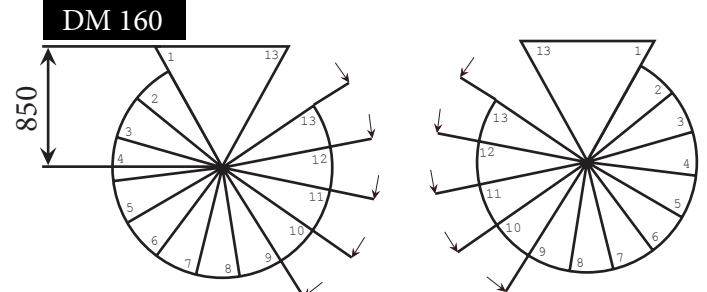
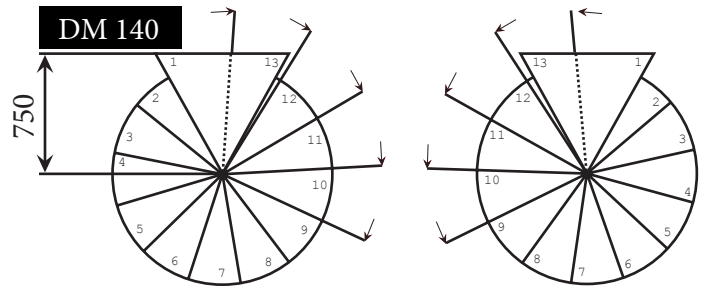
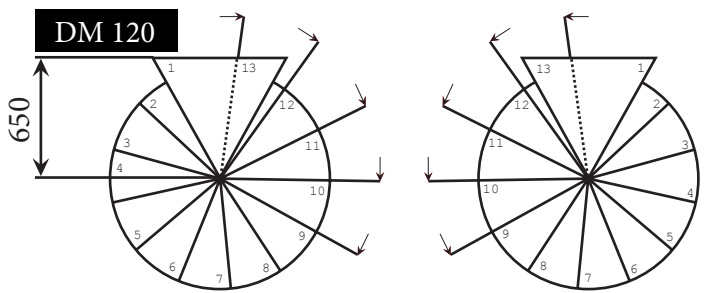
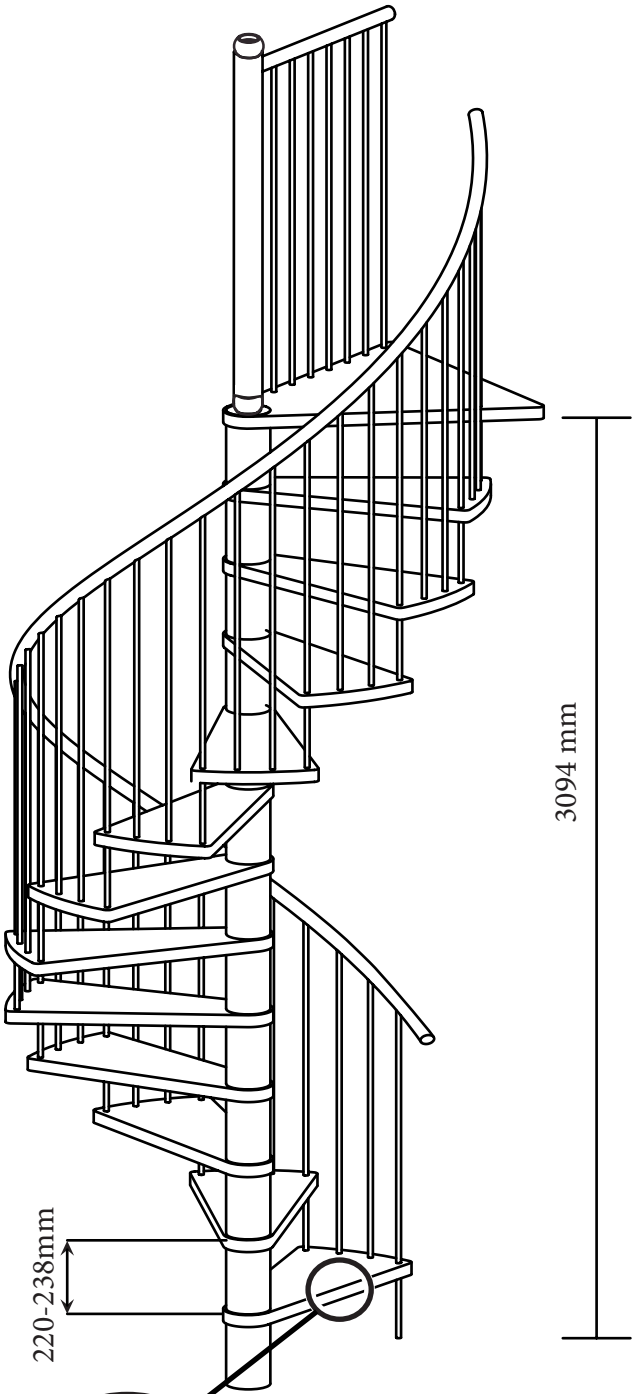



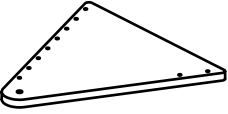
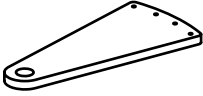
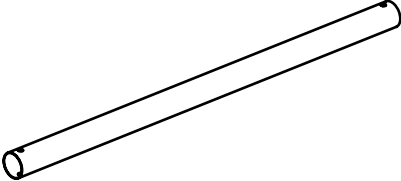
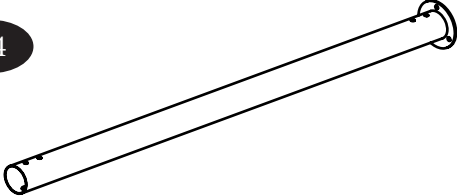
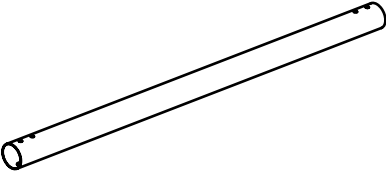
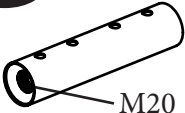
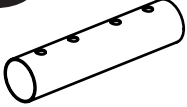
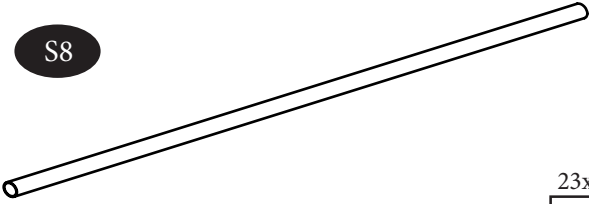

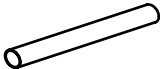
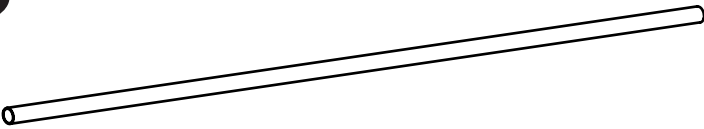
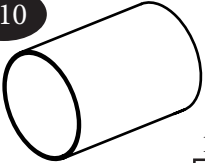
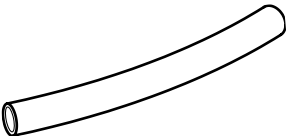
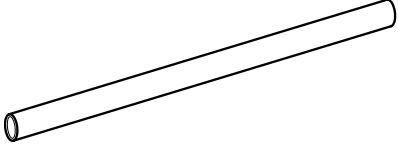
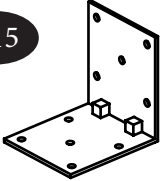
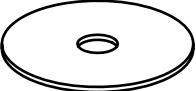
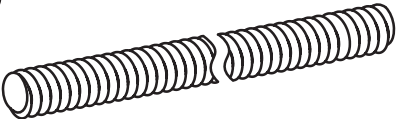



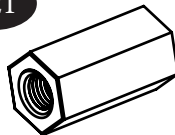

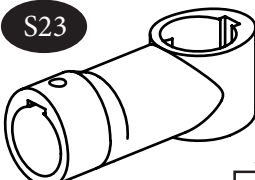
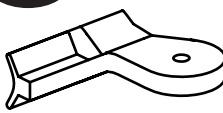

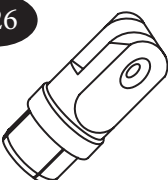

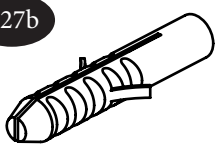

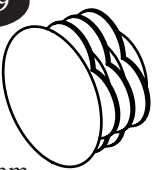

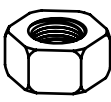

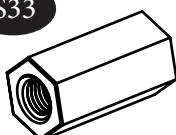

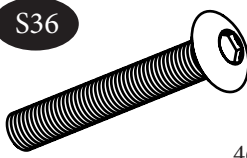
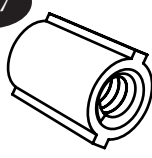
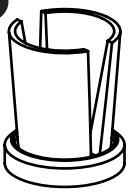
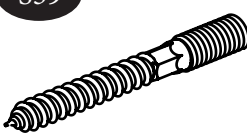
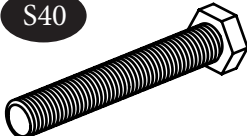
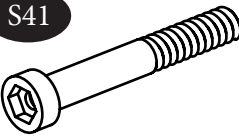
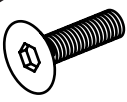

max. 200kg

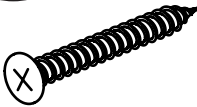
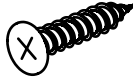

	W	D
120	600-650 mm	> 1200 mm
140	700-750 mm	> 1400 mm
160	800-850 mm	> 1600 mm

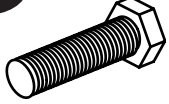
<p><b>S1</b></p>  <p>1x</p>	<p><b>S2</b></p>  <p>12x</p>	
<p><b>S3</b></p>  <p>910x50x1mm</p> <p>1x</p>	<p><b>S4</b></p>  <p>Ø60,2x1050mm</p> <p>1x</p>	
<p><b>S5</b></p>  <p>Ø60,2x1050mm</p> <p>1x</p>	<p><b>S6</b></p>  <p>M20</p> <p>Ø51x2,6x220mm</p> <p>1x</p>	<p><b>S7</b></p>  <p>Ø51x2,6x220mm</p> <p>1x</p>
<p><b>S8</b></p>  <p>Ø22x1x840mm</p> <p>23x</p>	<p><b>S11</b></p>  <p>Ø22x1x175mm</p> <p>14x</p>	<p><b>S12</b></p>  <p>Ø22x1x70mm</p> <p>1x</p>
<p><b>S9</b></p>  <p>Ø22x1x1100mm</p> <p>24x</p>		<p><b>S10</b></p>  <p>Ø127x2,9x179mm</p> <p>13x</p>
<p><b>S13</b></p>  <p>400x50x1mm</p> <p>12x</p>	<p><b>S14</b></p>  <p>952x50x1mm</p> <p>1x</p>	
<p><b>S15</b></p>  <p>90x90x80x3mm</p> <p>2x</p>	<p><b>S16</b></p>  <p>Ø100x3 d21mm</p> <p>1x</p>	<p><b>S17</b></p>  <p>M20 x 1000 mm</p> <p>2x</p>

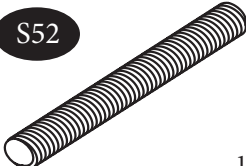
<p><b>S19</b></p>  <p>M8x1000mm</p> <p>6x</p>	<p><b>S20</b></p>  <p>M10x120mm</p> <p>1x</p>		
<p><b>S21</b></p>  <p>M20x60mm DIN6334</p> <p>1x</p>	<p><b>S22</b></p>  <p>Ø127x3mm</p> <p>104x</p>	<p><b>S23</b></p>  <p>3x</p>	<p><b>S24</b></p>  <p>46x</p>
<p><b>S25</b></p>  <p>Ø50mm</p> <p>17x</p>	<p><b>S26</b></p>  <p>46x</p>	<p><b>S27a</b></p>  <p>Ø8mm</p> <p>10x</p>	<p><b>S27b</b></p>  <p>Ø12mm</p> <p>2x</p>
<p><b>S28</b></p>  <p>Ø22mm</p> <p>1x</p>	<p><b>S29</b></p>  <p>Ø35mm</p> <p>5x</p>	<p><b>S30</b></p>  <p>M20 DIN934</p> <p>1x</p>	<p><b>S30a</b></p>  <p>M20 DIN439B</p> <p>1x</p>
<p><b>S31</b></p>  <p>M8 DIN434</p> <p>11x</p>	<p><b>S32</b></p>  <p>M5 DIN934</p> <p>46x</p>	<p><b>S33</b></p>  <p>M8DIN6334</p> <p>4x</p>	<p><b>S34</b></p>  <p>M6 DIN562</p> <p>6x</p>
<p><b>S35</b></p>  <p>M8x55mm</p> <p>3x</p>	<p><b>S36</b></p>  <p>M10x70mm</p> <p>46x</p>	<p><b>S37</b></p>  <p>M10</p> <p>50x</p>	<p><b>S38</b></p>  <p>74x</p>
<p><b>S39</b></p>  <p>M10x100mm</p> <p>2x</p>	<p><b>S40</b></p>  <p>M8x55mm DIN933</p> <p>3x</p>	<p><b>S41</b></p>  <p>M8x55mm DIN6912</p> <p>6x</p>	<p><b>S42</b></p>  <p>M5x20mm DIN7991</p> <p>46x</p>

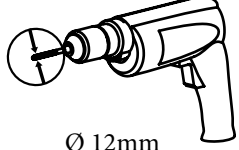
<p><b>S43</b></p>  <p>M6x6mm DIN914</p> <p>6x</p>	<p><b>S44</b></p>  <p>Ø6x50mm</p> <p>10x</p>	<p><b>S45</b></p>  <p>Ø6x30mm</p> <p>10x</p>	<p><b>S46</b></p>  <p>Ø3,9x19mm</p> <p>92x</p>
<p><b>S47</b></p>  <p>Ø30x3mm</p> <p>124x</p>	<p><b>S48</b></p>  <p>Ø16mm</p> <p>3x</p>	<p><b>S49</b></p>  <p>8x</p>	<p><b>S50</b></p>  <p>M8x14mm</p> <p>1x</p>
<p><b>S51</b></p>  <p>Ø4x25mm</p> <p>46x</p>	<p><b>S52</b></p>  <p>M10x300mm</p> <p>12x</p>	<p><b>S53</b></p>  <p>M10x35mm</p> <p>12x</p>	 <p>Ø 12mm Ø 8mm Ø 1,5mm</p>

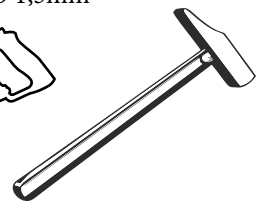
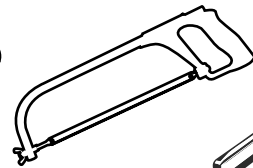
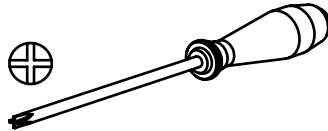
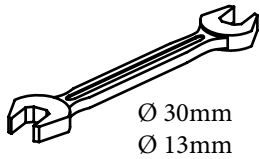
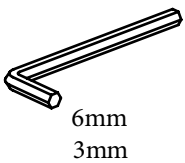

1

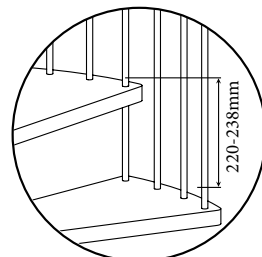
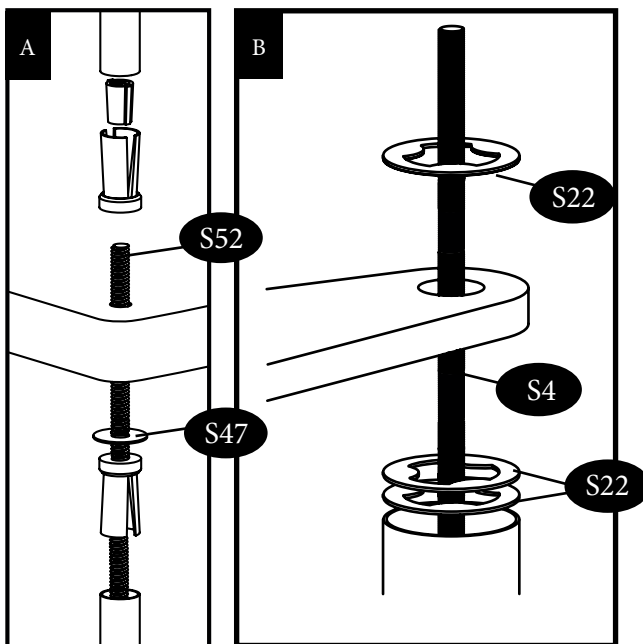

A	
0 x S47 =	220 mm
1 x S47 =	223 mm
2 x S47 =	226 mm
3 x S47 =	229 mm
4 x S47 =	232 mm
5 x S47 =	235 mm
6 x S47 =	238 mm
B	
2 x S22 =	220 mm
3 x S22 =	223 mm
4 x S22 =	226 mm
5 x S22 =	229 mm
6 x S22 =	232 mm
7 x S22 =	235 mm
8 x S22 =	238 mm

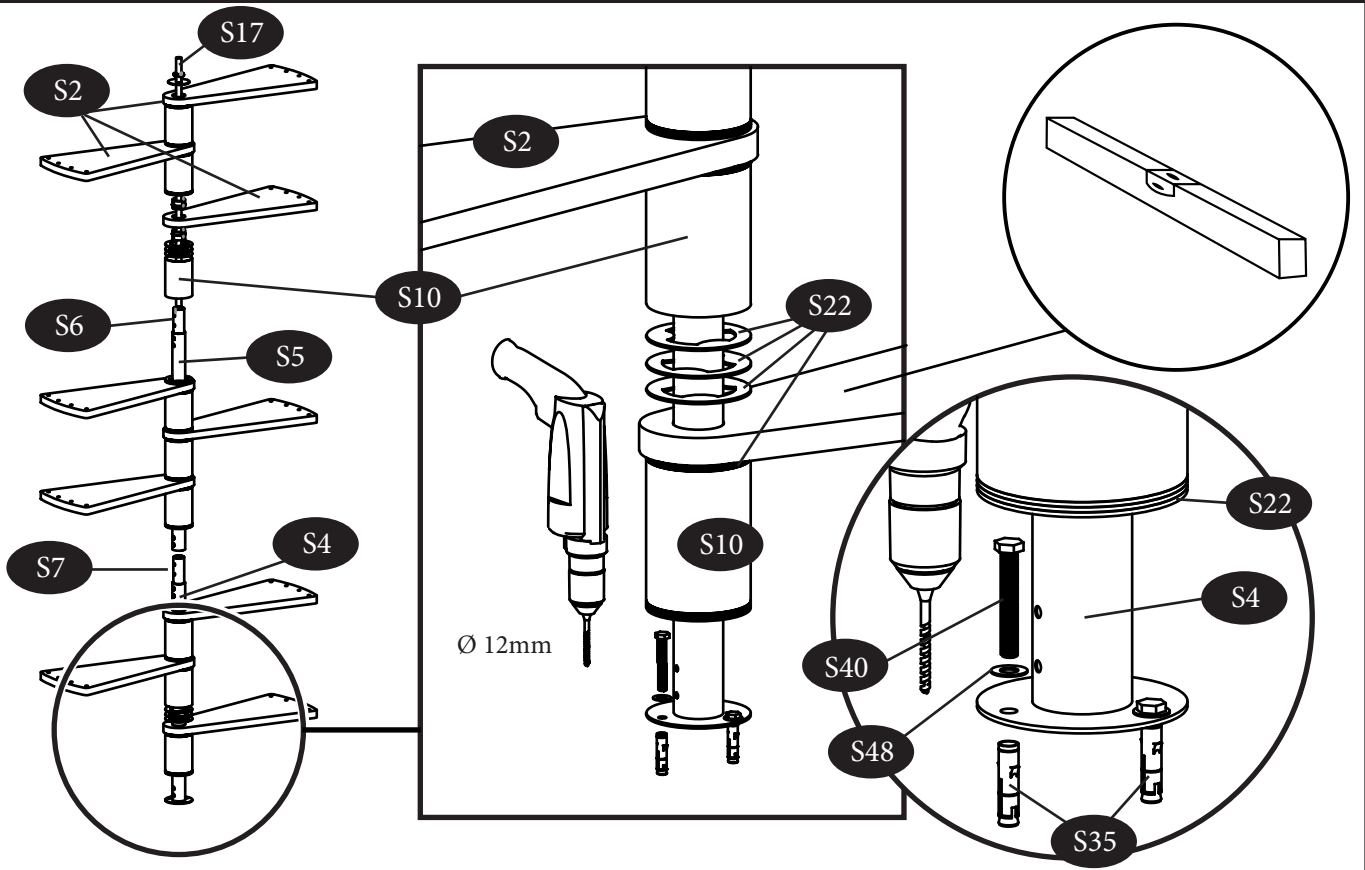

2

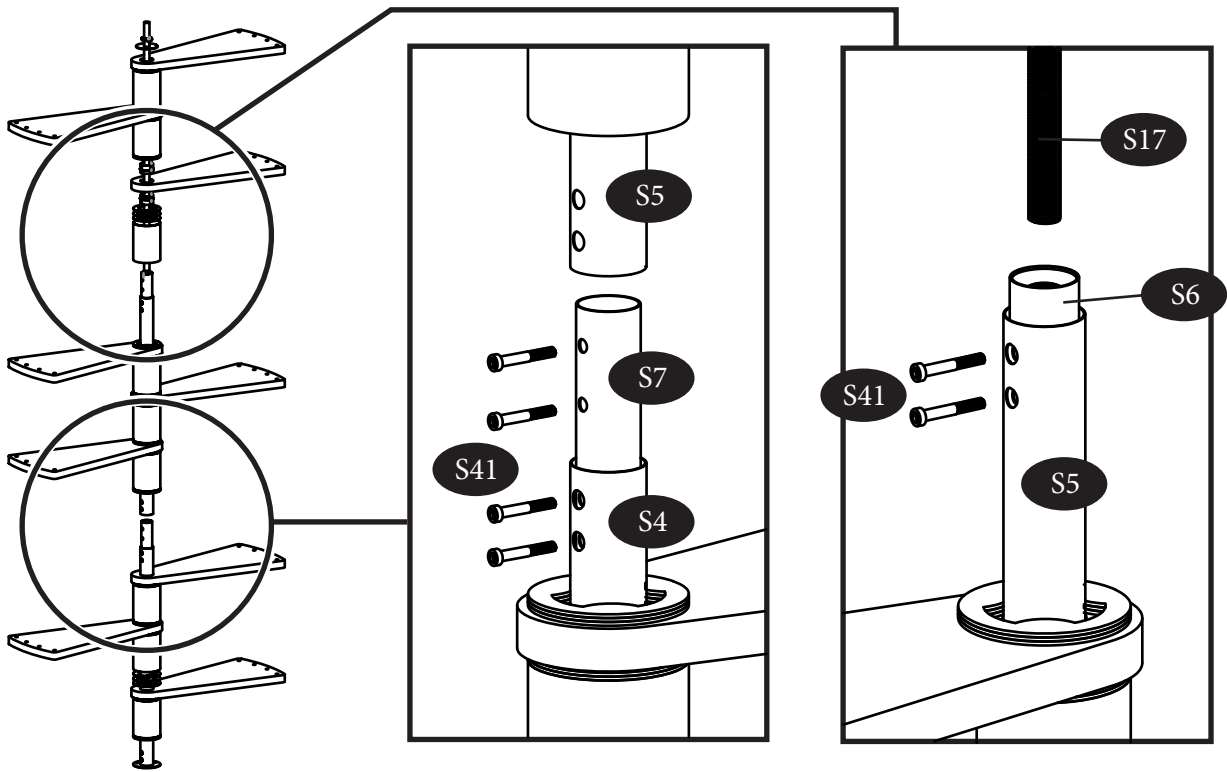

3

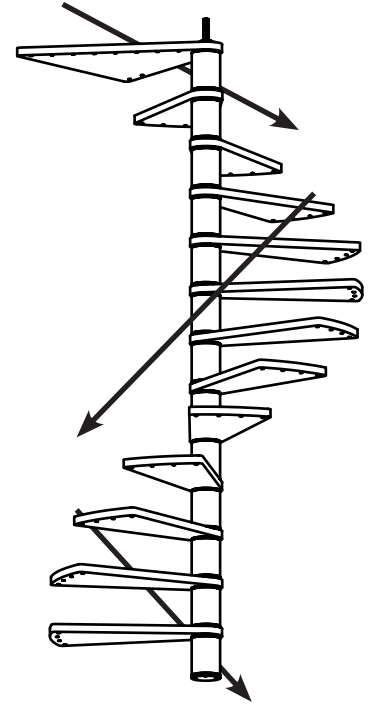
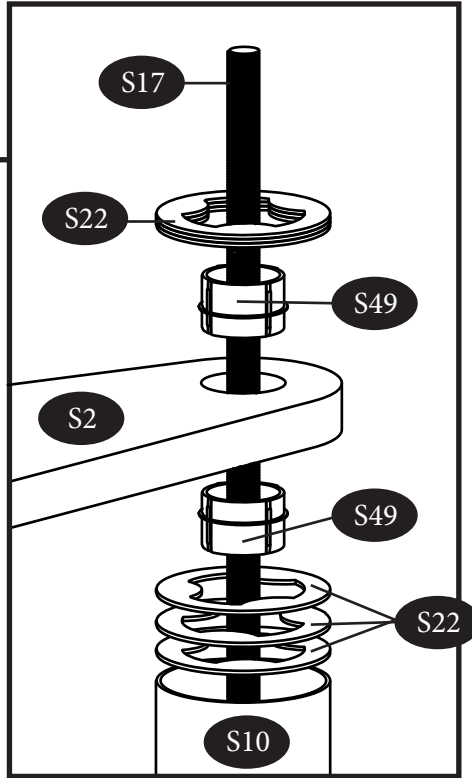
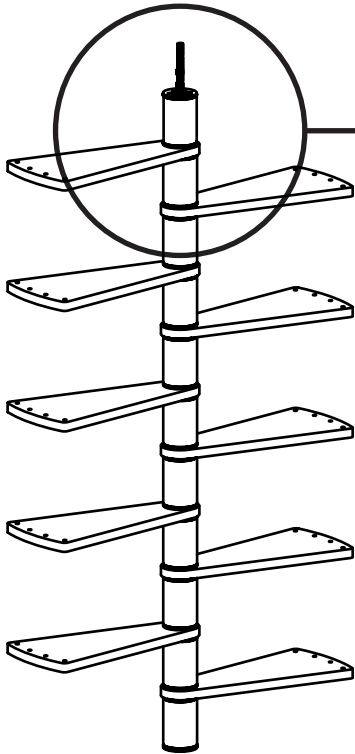

4

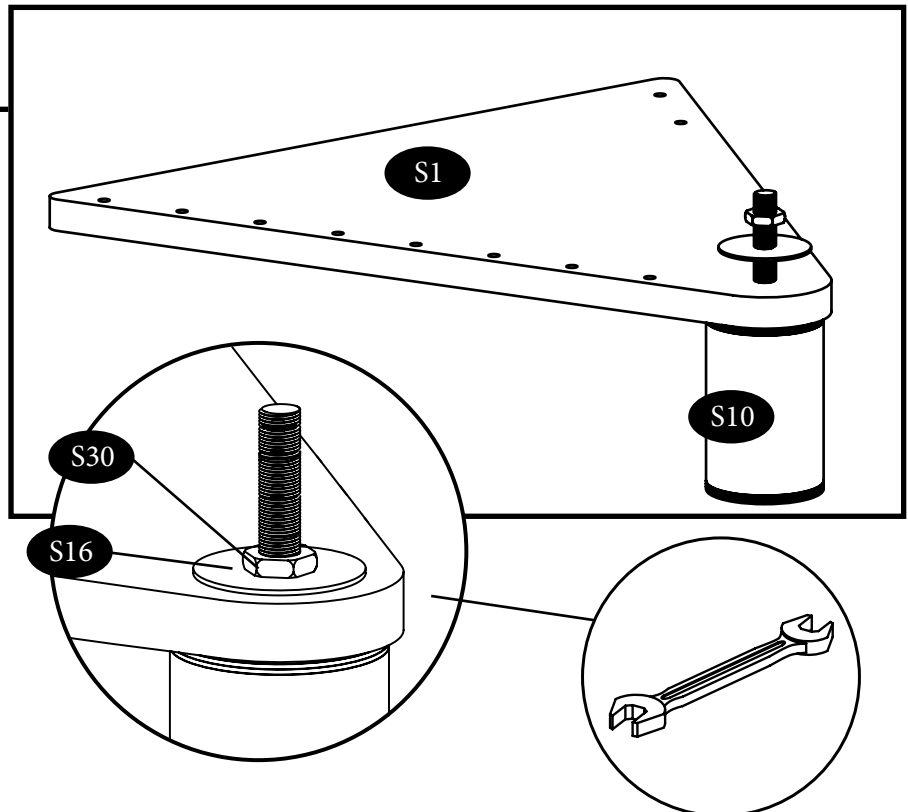
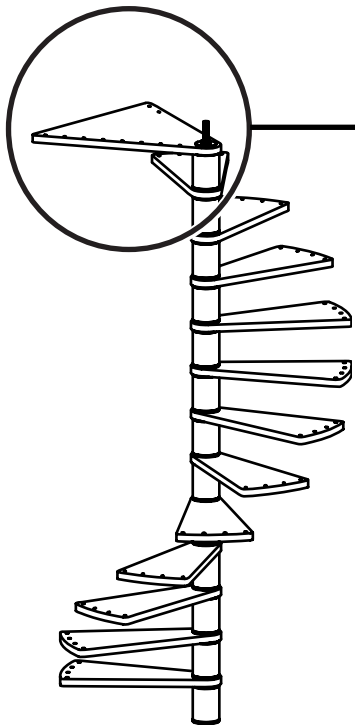

5

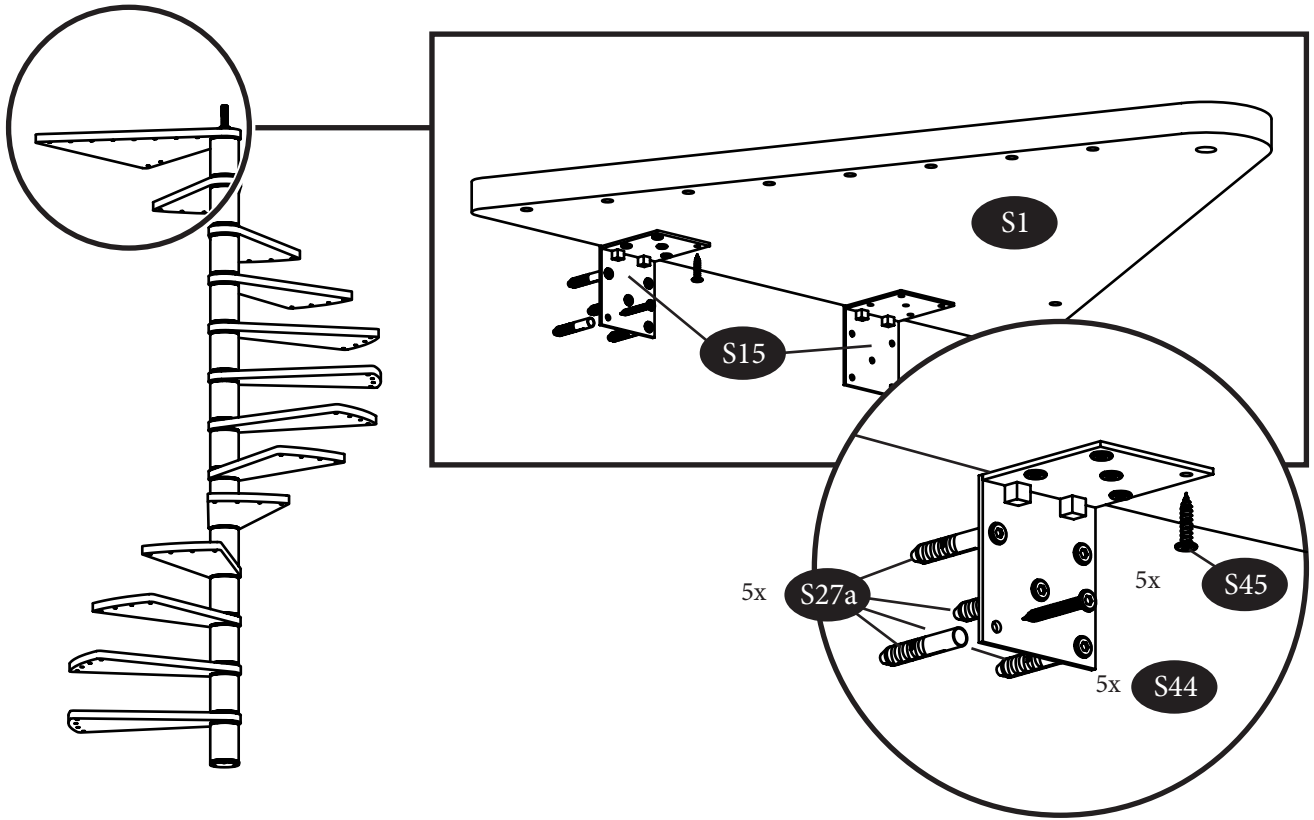

6

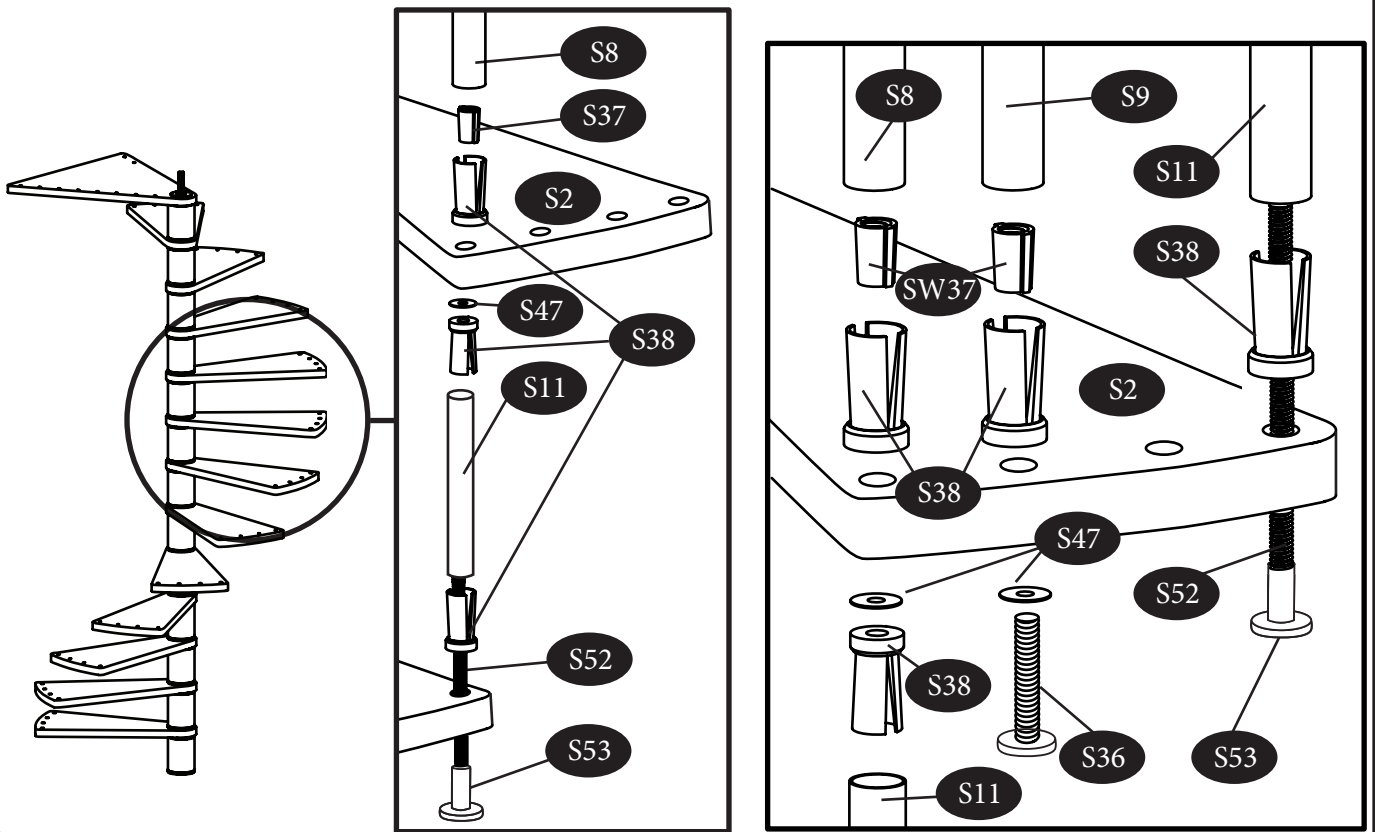

7

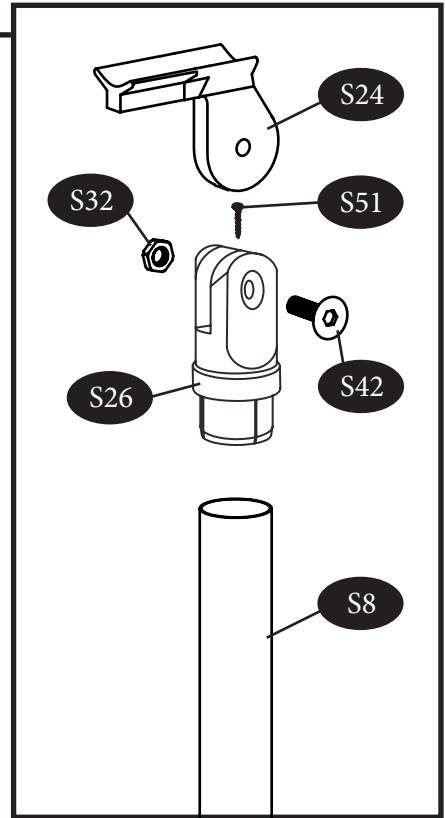
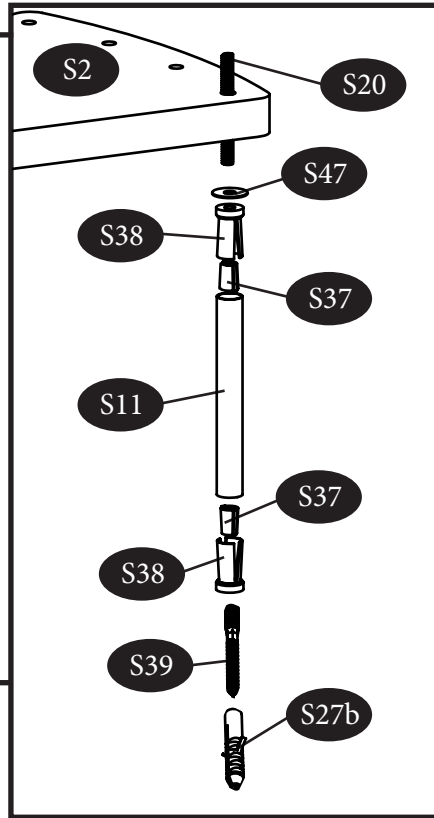
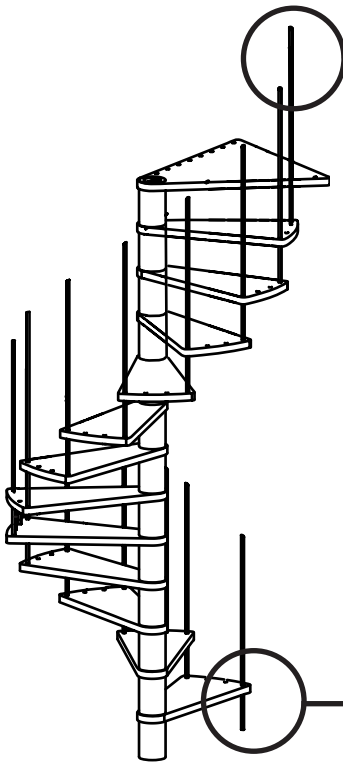

8

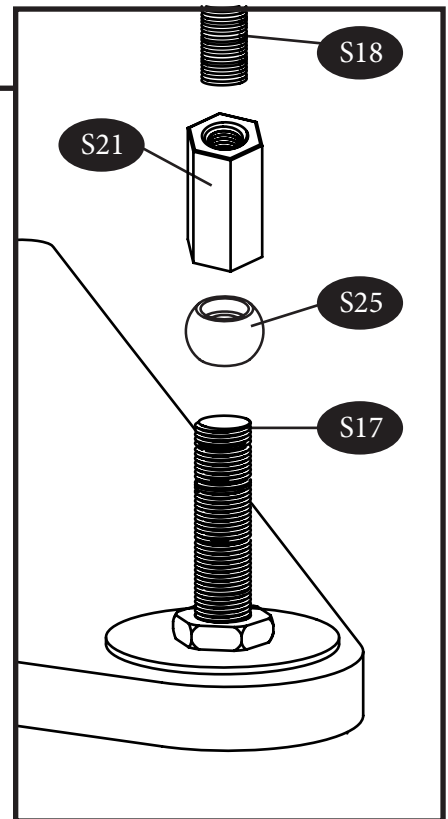
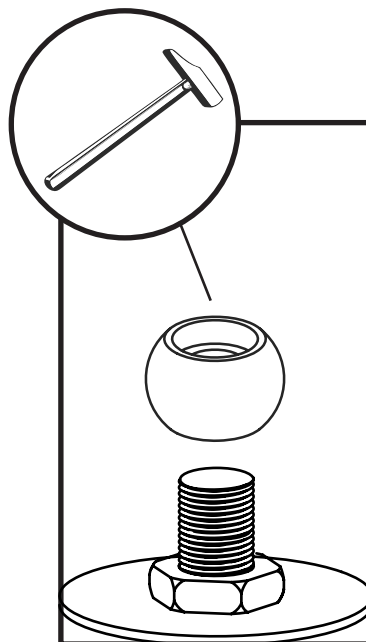
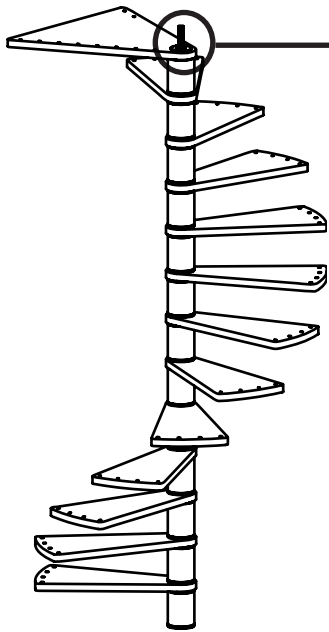

9



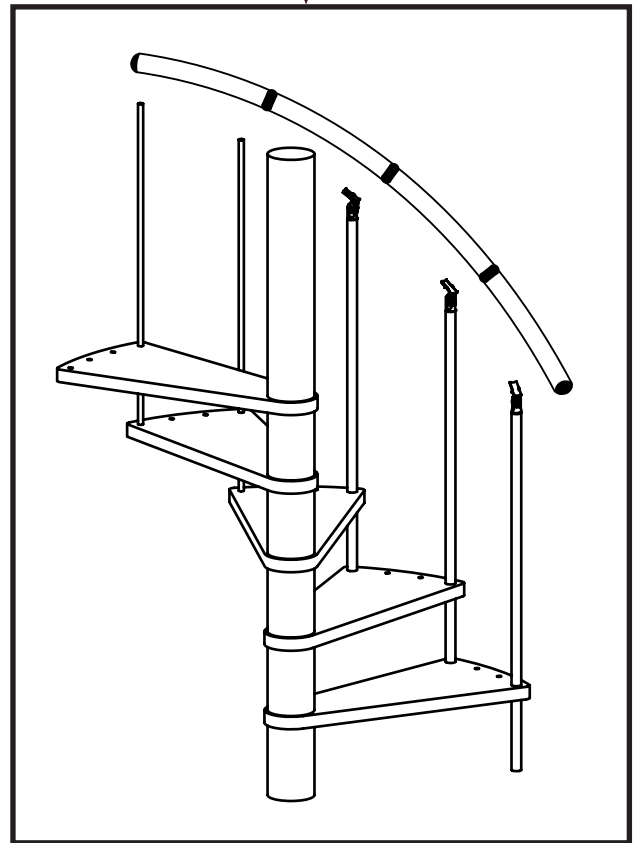
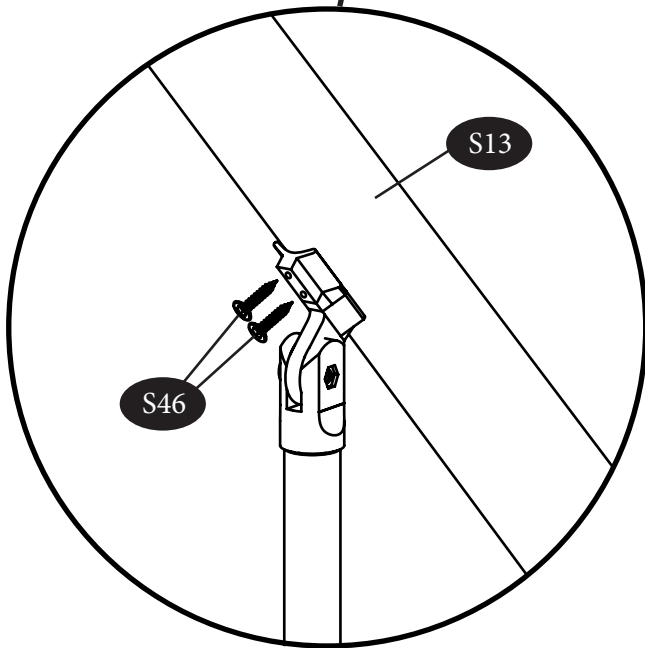
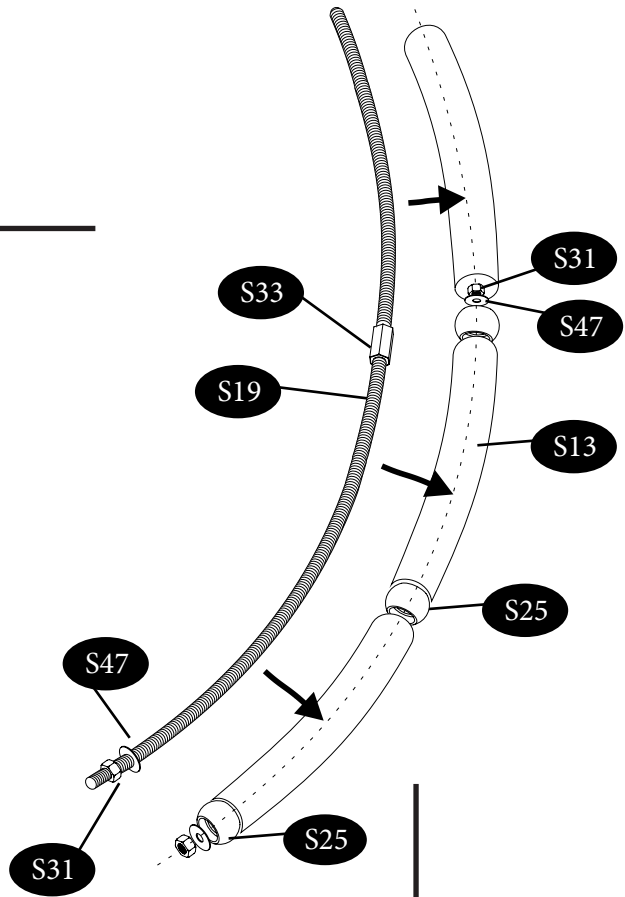
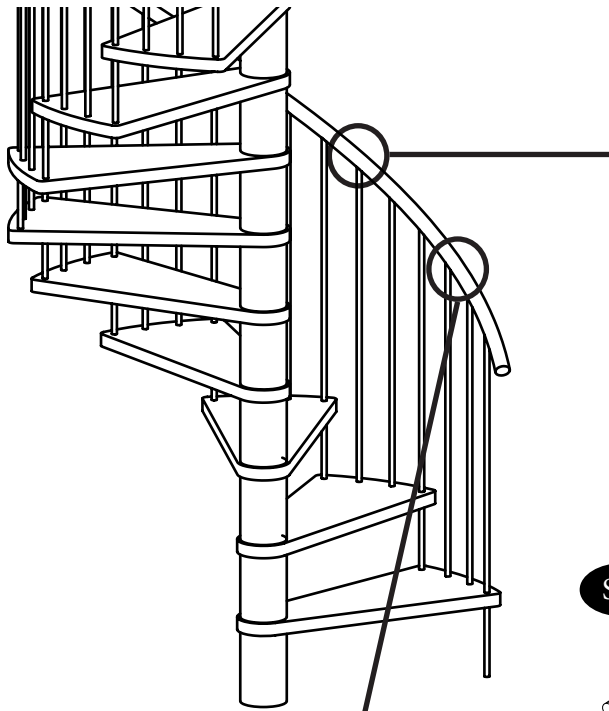

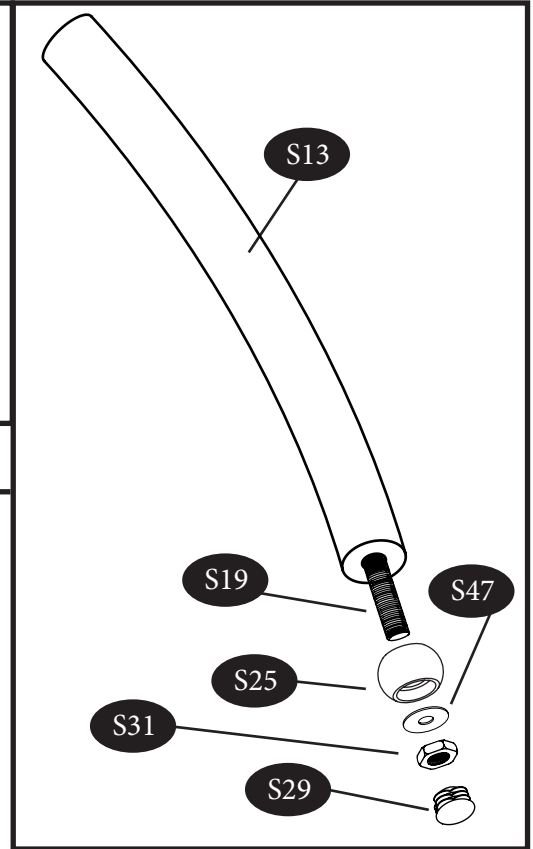
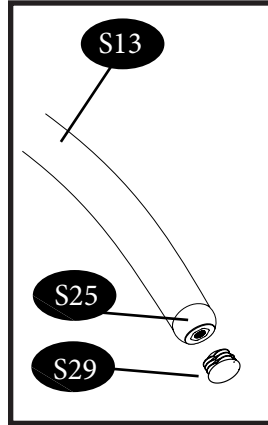
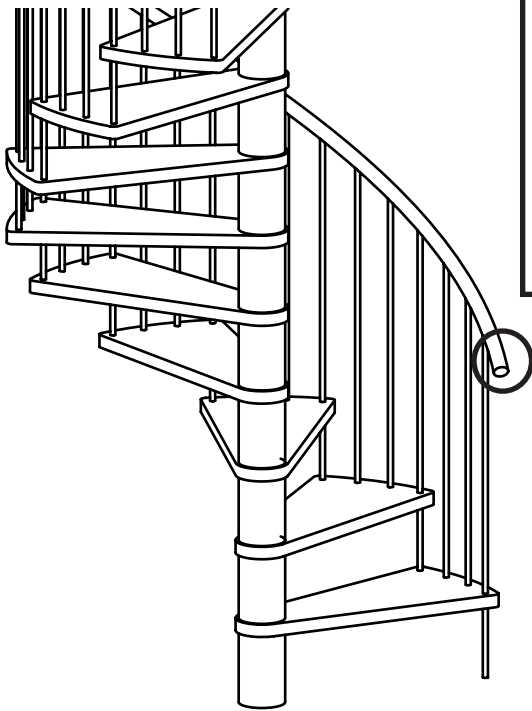

11

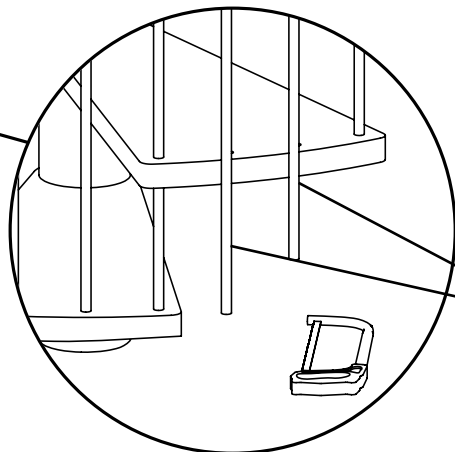
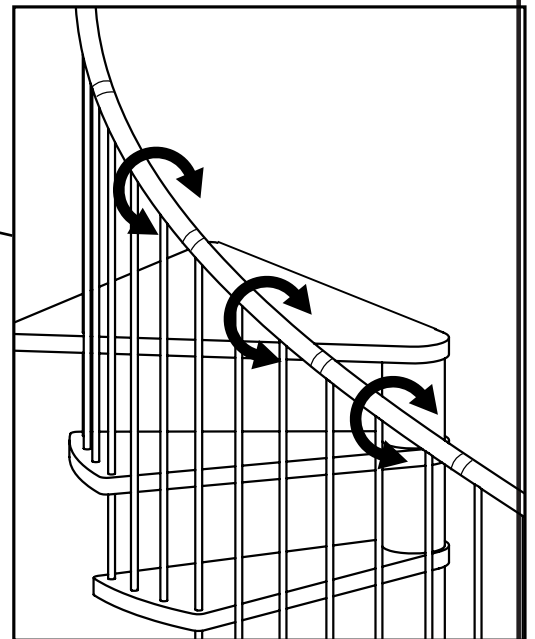
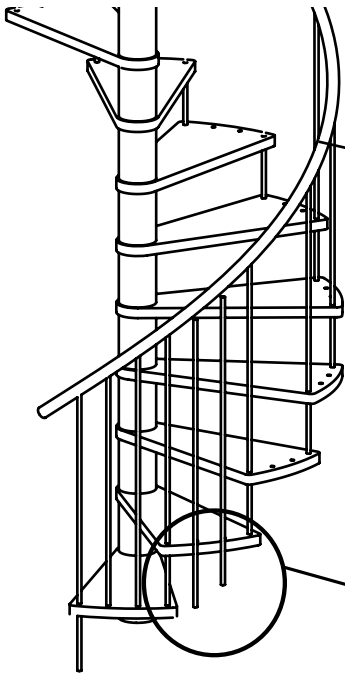

S9

12

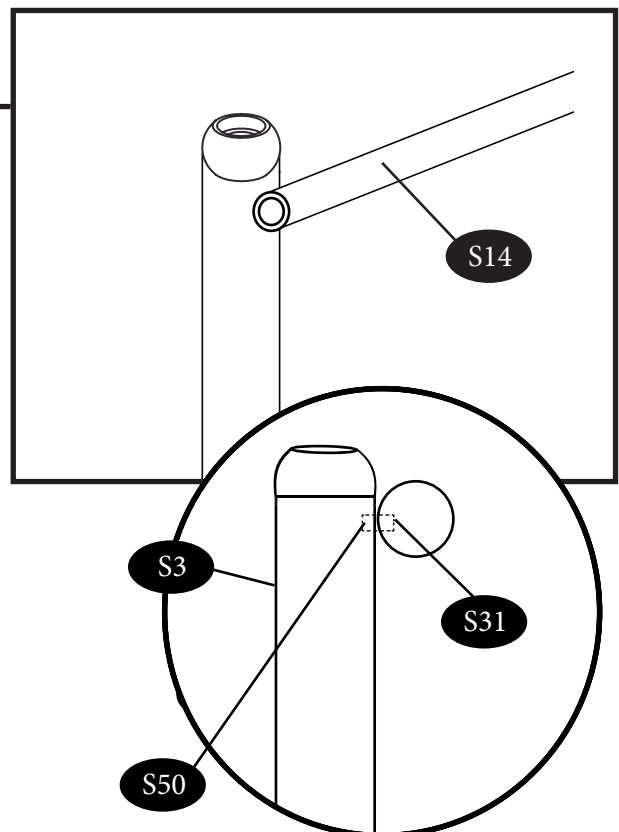
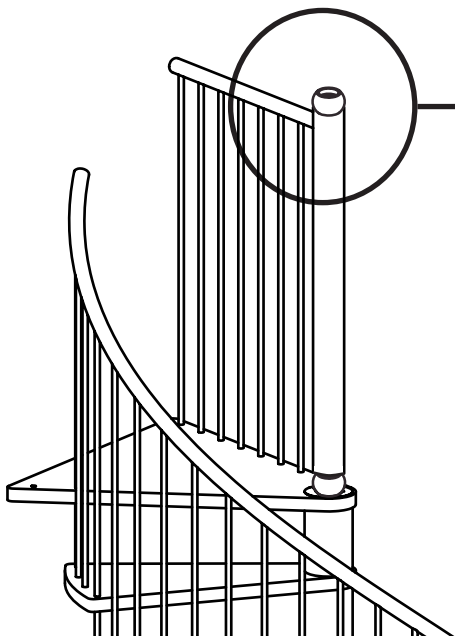
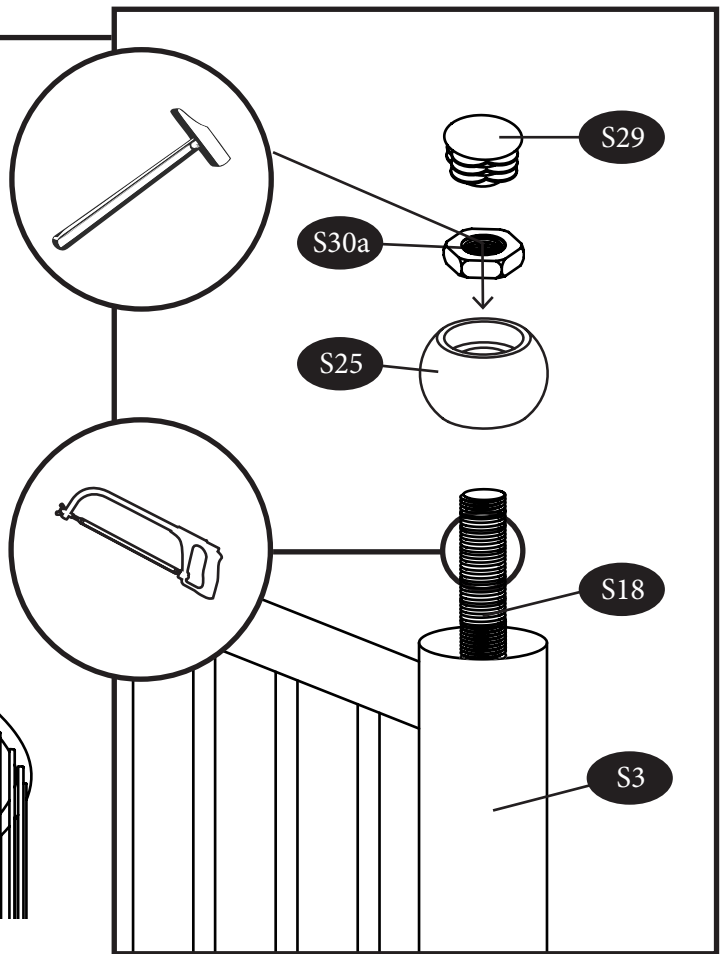
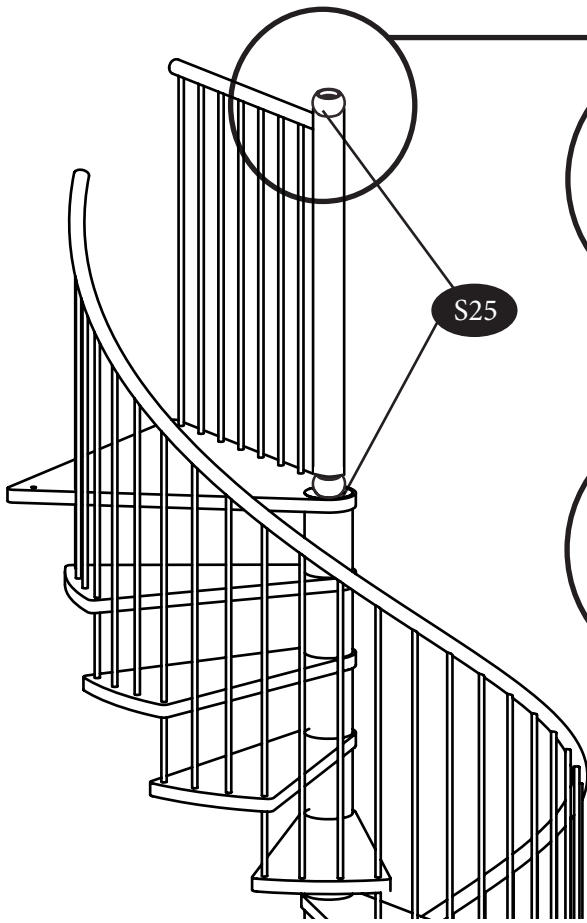

13

